

FireSAFE+ Residential

Grundfos Firefighting Systems

- Safety Instructions
- Installation & Operating Instructions
- CE & UKCA Declarations of Conformity



Installer Contact Details	
Name	
Company	
Tel (Regular hours):	
Tel (24 hour):	
Email:	
Model/Serial no:	
Install Date:	

FireSAFE+ Residential

Table of contents

1.0 Safety Instructions	
2.0 When and how to use the FireSAFE+ Installation & Operating instructions	
2.1 Symbols used in this document	
2.2 Scope of these Instructions	
2.3 Product Identification	
2.4 Product Description	
2.5 Key product components	
3.0 Installation and Operating Instructions	
3.1 Sequence of Operation	
3.2 Modes of operation	
3.3 Integration of Signals	
3.4 Mains power monitoring / Controller internal fuse monitoring	
3.5 Button Press Functions	
3.6 LED Operation	
3.7 Programming settings	
3.8 Extracting Data (Downloading the Log files)	
3.9 Factory settings	
3.10 Optional Features – Power Loss Alarm	
3.11 Annual service reminder	
3.12 Excessive pump operation / Leak detection	
4.0 General Information	
4.1 Delivery and handling	
4.2 Delivery inspection upon receipt	
4.3 Warranty	
4.4 Site storage	
4.5 Frost protection	
4.6 Operating environment	
4.7 Installation location	
4.8 Break tanks and mains water connection	
4.9 Installation - General requirements	
4.10 Installation and commissioning recommendations	
4.11 Pressure Switch settings	
4.12 Electrical connections	
5.0 Installation checklist	
5.1 Commissioning checklist	
5.2 System Verification checklist	
5.3 Operation	
5.4 User Inspection	
5.5 User maintenance	
5.6 Service & Annual test/Inspection	
5.7 Service & Annual test/Inspection checklist	
6.0 Technical Information	
6.1 Product Range – Electrical Requirement	
6.2 Product Range – Pressures and Flows	
6.3 Product Range –Dimensions & Weights	
7.0 Spare Parts	
7.1 De-commissioning, Dismantling and Disposal.	
7.2 De-commissioning	
7.3 Dismantling	
7.4 Disposal	
8.0 Fault finding checklist	
9.0 History log	
UKCA Declaration of Conformity	
EU Declaration of Conformity	

1.0 Safety Instructions

Original Safety Instructions

These safety instructions give an overview of the safety precautions to be considered in connection with any work on this product. Observe these safety instructions during handling, installation, operation, maintenance, service, and repair of this product.

These safety instructions are an explanatory section, and all safety instructions will appear again in the relevant sections of the installation and operating instructions.



Keep these safety instructions at the installation site for future reference.

Read this document before installing the product. Installation and operation must comply with local regulations and accepted codes of good practice.



This appliance is not for use by children and persons with reduced physical, sensory, or mental capabilities or lack of experience and knowledge. Children shall not play with the appliance. Cleaning and user maintenance shall not be completed by children.

Hazard: Transporting the Product



WARNING - *Falling objects.*

Death or serious personal injury.

- Secure the product during transportation to prevent it from tilting or falling.
- Do Not stack the product.



CAUTION - *Crushing of feet/Harm of body.*

Minor or moderate personal injury.

- Wear safety shoes when moving the product.

Hazard: Handling the product



CAUTION - *Back injury/Harm of body.*

Minor or moderate personal injury.

- Use lifting equipment.



CAUTION - *Crushing of feet/Harm of body.*

Minor or moderate personal injury.

- Wear safety shoes and gloves when moving the product.

Hazard: Mounting



CAUTION - *Crushing of feet/Harm of body.*

Minor or moderate personal injury.

- Place the product on a solid, level foundation suitable for the weight of the product when full of water.

Hazard: Mounting (continued)



CAUTION – *Noise in operation, structural vibration*

Minor or moderate personal injury.

- Ensure that the foundation will not transmit noise and vibration created by the unit that could be harmful. Avoid loft space installations.

Hazard: Electrical installation



DANGER - *Electric shock.*

Death or serious personal injury.

If requiring repair consult Grundfos, details on back page.



DANGER - *Electric shock.*

Death or serious personal injury.

- Check that the supply voltage and frequency correspond to the values stated on the nameplate.

Hazard: Protection against electric shock, indirect contact



DANGER - *Electric shock.*

Death or serious personal injury.

- Ensure that the unit is connected to protective earth and provide protection against indirect contact in accordance with local regulations.

Hazard: Cable cross-section



DANGER - *Electric shock.*

Death or serious personal injury.

- Always comply with local regulations as to cable cross-sections.

Hazard: Mains supply



DANGER - *Electric shock.*

Death or serious personal injury.

- Always use the recommended fuse size.

Hazard: Additional protection



DANGER - *Electric shock.*

Death or serious personal injury.

- Only use Residual Current Breaker with Over-Current (**RCBO**).

Hazard: Changing settings



DANGER - *Electric shock.*

Death or serious personal injury

- Switch off the power supply to the unit.

Wait at least 5 minutes before starting any work on the unit.

Make sure that the power supply cannot be accidentally reconnected.

Hazard: User interfaces



DANGER - *Electric shock*

Death or serious personal injury

- If the control panel is cracked, perforated, or damaged, immediately isolate and contact **Grundfos**, details on back page, to arrange a repair/replacement.

Hazard: Repair/Service the product



DANGER - *Electric shock*

Death or serious personal injury

- Switch off the power supply to the unit.

- Isolate the product from the power supply. Wait at least 5 minutes before starting any work on unit. Make sure that the power supply cannot be accidentally reconnected. Any work should only be conducted by a skilled and qualified person



DANGER - *Magnetic field*

Death or serious personal injury

- Do not handle the motor or rotor if you have a pacemaker.

Hazard: Cleaning the product



DANGER - *Electric shock*

Death or serious personal injury

- Isolate the product from the power supply. Wait at least 5 minutes before starting any work on unit. Make sure that the power supply cannot be accidentally reconnected. Check that the front controller cover is intact before spraying water or any non-abrasive, non-solvent cleaning solution on the product.

Hazard: Disposing of the product



The crossed-out wheellie bin symbol on a product means that it must be disposed of separately from household waste. When a product marked with this symbol reaches its end of life, take it to a collection point designated by the local waste disposal authorities.

The separate collection and recycling of such products will help protect the environment and human health.

See also end-of-life information at www.grundfos.com/product-recycling.

2.0 When and how to use the FireSAFE+ Installation & Operating instructions

Prior to **Installation, Commissioning and System Verification** of this product, the installer should fully read these Safety, Installation and Operating instructions.

The Installation and operation must also comply with local regulations and accepted codes of good practice.

The user is responsible for periodic inspection of the product, at a recommended interval of no more than 12 months.

The use of this product requires experience with and knowledge of the product.

Children and persons with reduced physical, sensory, or mental capabilities must not use this product, unless they are under supervision or have been instructed in the use of the product by a person responsible for their safety.

2.1 Symbols used in this document

WARNING/CAUTION



If these safety instructions are not observed, it may result in personal injury or damage to property/equipment.

DANGER



If these safety instructions are not observed, it may lead to electric shock with consequent risk of serious personal injury or death.

2.2 Scope of these Instructions

These Installation and Operating instructions apply to the: FireSAFE+

For Technical Information consult the FireSAFE+ Datasheet

For CRi Pump specific information please consult the CRi Installation and Operating manual and datasheets.

All the above documents are also available on the Grundfos Product Centre website at: www.grundfos.com/uk

2.3 Product Identification

The FireSAFE+ unit has a silver nameplate attached to the base. This label gives the following key information.

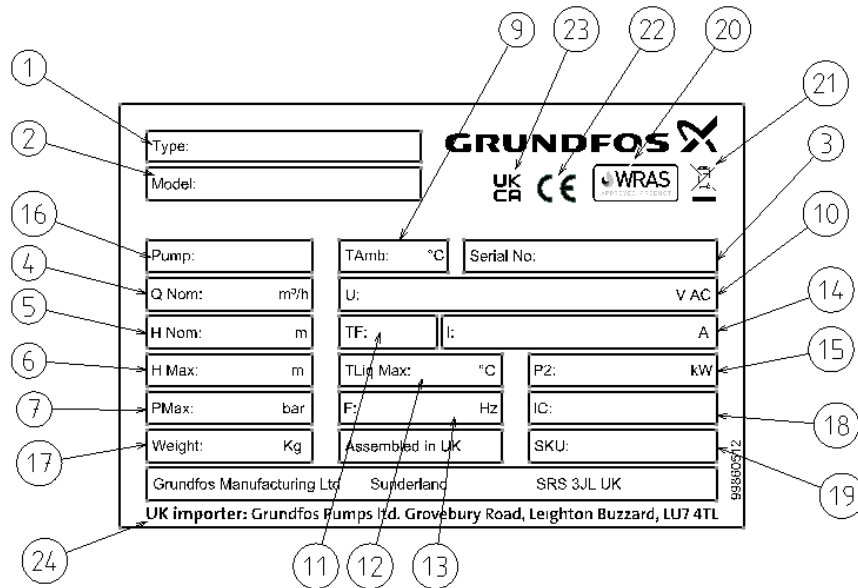

Reference	Key Characteristic
1	Product name - FireSAFE+
2	Pump Type
3	Model/Factory/Date Code/Serial No
4/5/6/7	Performance data
10/13/14/15/18	Electrical data
9/11/12	Temperature Data
16	CRi Pump Part Number
17	Weight
20/21/22/23/24	Approvals

2.4 Product Description

The Grundfos FireSAFE+ (Safe Active Firefighting Equipment) range of pump packages are designed to comply with the requirements of the following:

BS 9251:2021 - Fire sprinkler systems for domestic and residential occupancies.

Code of practice

EN 16925:2018 - Fixed firefighting systems. Automatic residential sprinkler systems.

Design, installation, and maintenance

LPS 1667 (pre-released version) - Requirements for pump sets used in domestic and residential: automatic sprinkler and low-pressure water mist installations

The following components come supplied with the **FireSAFE+** product:

FireSAFE+ Set, FireSAFE+ Installation and Operating Manual, CRi Pump I & O

Additionally, a **Battery Backup module** to sustain the buzzer alarm in the event of extended local power loss if available from RS. **RS Part number: 176-9373.**

Description - 2.4V NiMH Rechargeable Battery Pack (700mAh) with lead.

2.5 Key product components

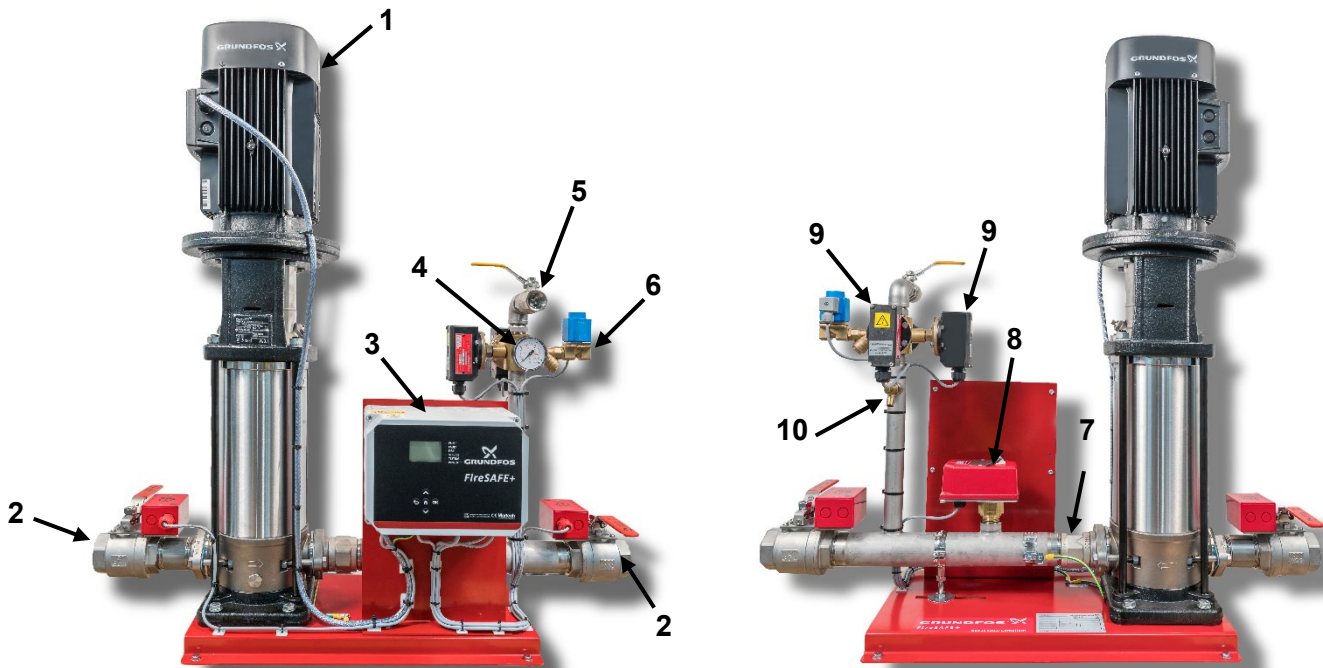

Identification	Component Description
1	CRi Pump
2	Monitored Lockable Ball Valve
3	Controller
4	Pressure Gauge & Gauge Shut off Valve
5	1" BSP Test Line
6	½" BSP Solenoid Valve
7	Non-Return Valve
8	Flow Switch LPCB Approved
9	Pressure Switch LPCB Approved
10	Drain Point

Pump (Item 1)

From the Grundfos high quality CRi pump range.

[See Pump data sheet for more info.](#)

Monitored Lockable Ball Valve (Item 2)

Model 120 BS9251:2021 Fully Lockable Ball Valve wired back to controller to give fault output and visual indication.

Controller (Item 3)

BS9251:2021 Controller available in 1ph DOL, 3ph DOL or 3ph Soft Start. Providing visual indications on screen and light indication. Datalogging and multiple features as standard.

Pressure gauge (Item 4)

Providing visual indication of the system pressure and for fine-tuning the pressure switch setting. Range of gauge 0 - 10 bar, 0 – 16 Bar or 0 – 25 Bar.

Test Line (Item 5)

1" BSP Test Line connection via a lockable ball valve.

Cooling Line (Item 6)

½" BSP cooling line solenoid to activate at timed intervals to prevent the pump overheating during a closed valve condition.

Non-Return Valve (Item 7)

Non-Return Valve to prevent backflow into the pump and maintain system pressure.

Flow Switch (Item 8)

LPCB approved flow switch to give indication of a sprinkler activation flow signalling back to controller and giving FIRE signal for monitoring remotely.

Pressure Switches (Item 9)

The FireSAFE+ unit operates directly from 2 x LPCB approved Bailey and Mackey pressure switches. The Pressure switches need adjusting to meet the site-specific requirements. [See section 4.13](#)

Drain Point (Item 10)

Drain point to allow system drainage without stripping down any parts to aid with testing and maintenance.

3.0 Installation and Operating Instructions

Original Installation and Operating Instructions

3.1 Sequence of Operation

The Grundfos FireSAFE+ supplies water, usually from a storage tank, via a riser system within the building to a system of sprinkler heads.

Should the pressure in the sprinkler system decay, through minor leakage, then the FireSAFE+ unit will detect this pressure drop, via inbuilt pressure switches and run the pump to re-pressurize the system (**Jockey Mode**). If the pressure switches remain active or re-activate within a small-time window, then the FireSAFE+ will run the pump in jockey mode then enter **Possible Fire Mode**.

Possible Fire Mode runs the pump until manually stopped via the restoration of pressure in the system and the pressing and holding of the up and down button on the front of the controller for 2 Seconds. If the unit is connected to a Fire Alarm panel, it will send a Fault signal from the FireSAFE+ unit to the Fire Alarm Panel. During **Possible Fire Mode** the cooling line, if installed, is active. This protects the pump from a potential no flow condition.

Should a sprinkler head activate then the resulting flow in the system will trigger the system flow switch which will report a flow of water to the FireSAFE+ unit which in turn will put the pump in **Fire Mode**. **Fire Mode** runs the pump until manually stopped via the restoration of pressure in the system, resulting in the end of the flow signal, and the pressing and holding of the up and down button on the front of the controller. If the unit is connected to a Fire Alarm panel, it will send a **FIRE** signal from the FireSAFE+ unit to the Fire Alarm Panel.

The FireSAFE+ unit also performs an **Auto test** on a weekly basis to ensure that it is fault free and the pump is available on demand. During this test, the Cooling line valve opens, releasing a small amount of water, causing a system pressure drop. The controller monitors both pressure switches and detects the drop in pressure. The controller activates the pump and continues to monitor. It runs the pump to increase the pressure until it detects the de-activation of both pressure switches. Upon de-activation of both pressure switches, the pump stops, and the system should be back up to desired pressure. The **Auto test** result records in the Log file. A failed **Auto test** results in the unit flagging a Fault condition.

Auto test can be replicated at any time, see **Manual test**, [see section 3.2](#)

All Controller/Pump activities log in the FireSAFE+ units' memory for extraction via USB in report formats.

3.2 Modes of Operation

The FireSAFE+ unit is specifically designed by Grundfos to assist system designers and installers with complying to the BS, EN and LPS standards, integrating key system signals, monitoring system conditions and to operate automatically.

The FireSAFE+ controller has the following modes of Operation:

- **Jockey Mode** - Pressure maintenance
- **Possible Fire Mode** – Pressure Switch triggered only
- **Fire! Mode** – Flow switch confirmed Fire
- **Auto Test Mode** – Weekly self-test
- **Manual Test Mode** – Same as Auto Test Mode

Jockey Mode – System pressure maintenance.

If the system pressure decays enough to activate one or both pressure switches, the FireSAFE+ unit will run the pump for a programmable time period (Factory set at 10 seconds). This should be sufficient to re-pressurize the system.

The maximum number of maintenance cycles within a 7-day period before the system registers this as a fault is programmable up to a maximum of 30 (Factory set at 10 starts/week). It can also be disabled, but this is the responsibility of the installer/user thereafter. This cycle count excludes the automatic weekly pump self-tests.

On exceeding the maximum maintenance cycles the Fault LED on the Control panel and Fault Digital output activates requiring attendance to reset. The FireSAFE+ units' operation is not impaired.

Possible Fire Mode – One or both pressure switches detected Fire

Following a Jockey Mode operation, the FireSAFE+ monitors the pressure switches during a small programmable time period. If the pressure switches remain active or re-activate during this time window, the FireSAFE+ will run the pump in Possible Fire Mode.

Possible Fire Mode runs the pump until the restoration of pressure in the system and manually stopped by the pressing and holding of the up and down button on the front of the controller. Possible Fire Mode activates the Fault LED on the Control panel and Fault Digital output requiring attendance to reset. The FireSAFE+ units' operation is not impaired.

During Possible Fire Mode the cooling line is active, protecting against running the pump against a potential no flow condition. A Fire Alarm signal will not generate; hence no contact made to the Fire Brigade. A Fault alarm will raise.

Fire! Mode – Flow switch = Confirmed Fire

Should a sprinkler head activate then the resulting flow in the system will trigger the system flow switch which will report a flow of water to the FireSAFE+ unit which in turn will put the pump in Fire Mode. Fire Mode runs the pump until manually stopped via the restoration of pressure in the system, resulting in the end of the flow signal, and the pressing and holding of the up and down button on the front of the controller. Fire Mode activates the Fire! LED on the Control panel and Fire Digital output requiring attendance to reset.

Auto test Mode – Weekly test

The FireSAFE+ unit performs an Auto test on a weekly basis to ensure that it is fault free and the pump is available on demand. During this test, the solenoid valve opens, releasing a small amount of water, causing a system pressure drop. The controller listens for the activation of both pressure switches then runs the pump to restore the pressure while listening for the de-activation of both pressure switches.

The Auto test result records in the Log file. A failed Auto test results in the activation of the Fault LED on the Control panel and Fault Digital output requiring attendance to investigate the problem and reset.

Manual test Mode

Auto test can be replicated at any time, this is called the “weekly test”. [See section 3.5](#)

3.3 Integration of Signals

The FireSAFE+ unit is specifically designed with the ability to power and relay digital signals. The signals could be from any source, but Grundfos suggest the following important signals:

- Flow Switch
- Low Water Level

The Flow switch device is the only device allowable under BS9251:2021 to determine the presence of a fire and to activate Fire Mode. Water flow switches normally incorporate an adjustable delay option. This should be optimized with the programmable delay in the controller to the site conditions to prevent activating the Fire Alarm unnecessarily or delaying Fire activation. Consult the documentation supplied with your device.

The Low water level switch device, to give a warning once the water storage capacity is reduced below the low-level mark. The signal needs to be present for more than the programmable delay in the units’ settings before the controller activates the output.

The digital inputs are supplied with a current limited 12V DC Voltage which can be applied to digital switching devices. Upon switching, the digital inputs are connected to the volt-free outputs. This allows Volt-Free output to Alarm Control Panels, Sirens, etc.

Voltage wetted inputs negate the requirement for an additional power source to supply the digital signalling device. The inputs are optically connected to the outputs and therefore voltage/current isolated from each other.

3.4 Mains power monitoring / Controller internal fuse monitoring

On the application of mains electrical power, the screen will become visible and the Power LED on the controller front panel illuminates and the Fault output moves to its healthy position.

Upon failure of the mains power or the controller's internal fuse the LED extinguishes, the Fault relay moves to its unhealthy position and after more than 2 hours without power the internal buzzer activates for 1 second every 30 minutes. This will continue until the mains power is restored. The loss of mains power and the restoration of mains power are both recorded in the data logs.

The controller front looks like the below and has a screen with buttons to perform various functions and scroll through the menu:



3.5 Button Press Functions

FireSAFE+ Residential Controls & LEDs

From the main screen, press and hold the following key combinations (simultaneous key press same colour) to initiate basic functions:

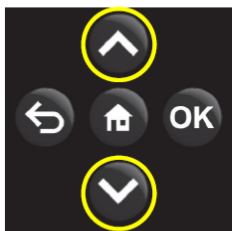

STOP! Clear Fire Mode

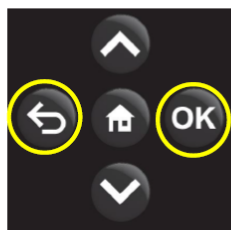

START - Put in FIRE mode



TEST – Start ‘weekly test’



RUN PUMP for 10secs
(Press & hold for 5 secs)

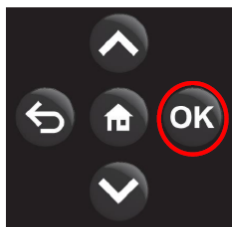

SILENCE SOUNDER
Press OK for 2 secs

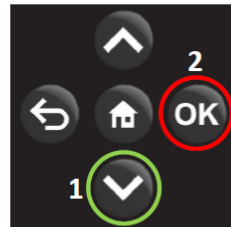

FAULT - Arrows to scroll,
OK to clear selected fault.

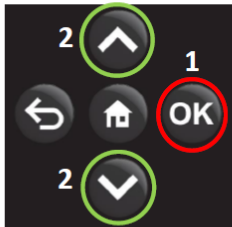

SETUP - Press and hold OK 5 secs
then use arrows to navigate

Note – a PIN No. is required to access different levels of user menus – please refer to Grundfos for this information.

3.6 LED Operation

LED FUNCTIONS

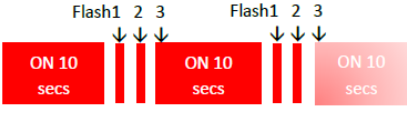

LED	Function
PUMP (yellow)	ON = pump running
FAULT (red)	<p>The LED stays on for 10 seconds then flashes according to the fault. At the last flash the LED stays on for 10 seconds before the sequence is repeated (see below example for 3 flashes).</p> <p>2 flashes - Auto_Test_Failure 3 flashes - Low_Water 4 flashes - Pressure_Switch1_Failure 5 flashes - Pressure_Switch2_Failure 6 flashes - Excessive_Operation 7 flashes - Phase_Failure 8 flashes - Maximum_Run_time 9 flashes - Solenoid_Valve_Failure 10 flashes - Possible Fire (no flow detected)</p> 
FIRE! (red)	Flash 2Hz (0.5 secs) = Fire mode
SERVICE (blue)	Flash 1Hz (1 sec) = Service required
TESTING (orange)	<p>Flash every 2 seconds = Dump Valve open</p> <p>ON = Remainder of auto test in progress OR</p> <p>ON = Wait period after operation (e.g., after jockey mode)</p> <p>Also</p> <p>ON when a USB stick is inserted and read/write is in progress (sounder sounds when read/write is complete)</p>
POWER (green)	Mains power available

The controller will visually indicate the LED's below and show faults with text on the screen shown in the example below:



3.7 Programming settings

FireSAFE+ is factory-configured with standard settings that should be suitable for most installations. These settings should be verified onsite by the commissioning engineer. Where required, these settings are adjustable. See below for instructions on uploading advanced settings from a USB memory stick.



The USB configuration feature is intended for use by qualified installers ONLY. Changing the settings incorrectly could result in the system failing to operate correctly.

USB device requirements:

Formatted FAT32, Size 1Gb < > 65Gb, no other files on the device, root directory only to be used (no folders).



This process is only for suitably qualified electrical persons, not the end user.

Process: (Programming settings/Extracting Data Logging):

- TURN OFF - **Follow a Safe Isolation Procedure before working on the unit.**
- Remove the Front cover and lay it flat, face down on a soft surface to prevent scratching.
- Insert USB memory stick device into the USB port.
- Turn ON, wait a few seconds for the unit to beep.
- TURN OFF - **Follow a Safe Isolation Procedure before working on the unit.**
- Remove USB memory stick device and replace the front cover

Programming settings

A text file called settings.txt, available from Grundfos, can be used to customize the unit values with the aid of a laptop before saving these to the USB device. Then performing the process described above.

This text file is pre-formatted and allows for the customization of settings by editing the values with a laptop/pc in the Windows Notepad editor.

Settings files MUST follow the settings.txt file syntax exactly.

Additional or missing characters and spaces are not permitted and may prevent correct operation.

All text after the semi-colon (;) are comments only and are not used by the system.



The USB configuration feature is intended for use by qualified installers ONLY. Changing the settings incorrectly could result in the system failing to operate correctly.

On completion the unit will update, USB device will have a record saved to it from the FireSAFE+ unit of the settings and history before the change. The settings.txt file will also change to settings.old. This is a safety measure to prevent accidental reuse. To revert the settings.old file to settings.txt simply rename the extension back to .txt.

Time and date enable an approximate time/date to be set on the FireSAFE+ for time stamping of activity logs.

3.8 Extracting Data (Downloading the Log files)

Perform the above process. The USB memory device will now have 4 text files on.

- **Autotest Log**
(records results of all Autotest cycles, Auto or Manually initiated)
- **Fault**
(records the number and name of the fault and when it occurred)
- **Configuration**
(records current configuration of the unit)
- **Pump Run Log**
(records Pressure switch and flow switch activation)

The name of these files will have a date and time stamp on them.

Examples of Log Files.

```
Pump Run Log 06032023 1534.txt - Notepad
File Edit Format View Help
Device Name: FireSAFE+
Grundfos Pumps Ltd.
01525 85 00 00
Installer Name: INSTALLER NAME 1
INSTALLER NAME 2
INSTALLER NAME 3
Installer Contact details: CONTACT DETAILS 1
CONTACT DETAILS 2
CONTACT DETAILS 3

Jockey/Fire mode run 1 of 3
Date - 23/03/2023
Time - 13:17
Pressure Switch 1 activated? - Yes
Pressure Switch 2 activated? - Yes
Flow Switch activated? - No
```

Pump Run

```
Autotest Log 01032023 1624.txt - Notepad
File Edit Format View Help
Device Name: FireSAFE+
Grundfos Pumps Ltd.
01525 85 00 00
Installer Name: INSTALLER NAME 1
INSTALLER NAME 2
INSTALLER NAME 3
Installer Contact details: CONTACT DETAILS 1
CONTACT DETAILS 2
CONTACT DETAILS 3

Auto test 1 of 2
Date - 01/03/2023
Time - 15:43
Pressure Switch 1 activated? - Yes
Pressure Switch 2 activated? - Yes
Pressure Switch 1 deactivated? - Yes
Pressure Switch 2 deactivated? - Yes
Flow Switch activated? - No
Test duration OK? - Yes
Test Passed? - Yes
```

Auto Test

```
Fault 06032023 1530.txt - Notepad
File Edit Format View Help
Device Name: FireSAFE+
Grundfos Pumps Ltd.
01525 85 00 00
Installer Name: INSTALLER NAME 1
INSTALLER NAME 2
INSTALLER NAME 3
Installer Contact details: CONTACT DETAILS 1
CONTACT DETAILS 2
CONTACT DETAILS 3

power cycle 1 of 1
power off Date - 07/03/2023
Time - 09:07

power on Date - 07/03/2023
Time - 09:08

Fault 1 of 1
Fault Type - Possible Fire Mode
Date - 07/03/2023
Time - 09:09
```

Fault

3.9 Factory settings

The FireSAFE+ unit will come already set with the below values. Time and Date is programmed in the factory and supported by a battery backup.

Current Time:- {{Time}};
Current Date:- {{Date}};
Service Reminder:-ON; ON or OFF
Service Interval:-12; 1 to 12 Months
Low Water Delay:-10; 0 to 60 Seconds
Maximum Run:-OFF; click to change
Maximum Run Time:-480; 1 to 480 Minutes
Excessive Operation Limit:-10; 0 to 30 Starts/week
Jockey Pump Duration:-10; 5 to 120 Seconds
Flow Switch Delay:-3; 0 to 25 Seconds
Pressure Switch Delay:-0; 0 to 10 Seconds
Fire Mode Wait:-5; 1 to 30 Seconds
Device Name:-FireSAFE+ Resi
; three lines each less than 21 characters
Installer Name:-Grundfos Pumps Ltd
; three lines each less than 21 characters
Installer Contact details:-01525 850000
; three lines each less than 21 characters
Auto test Duration:-60; 60 to 600 Seconds
Auto test Open:-15; 1 to 90 Seconds
Auto test Period:-7; 1 to 30 Days
Cooling line Duration:-5; 0 to 60 Seconds
Cooling line Cycles:-30; 1 to 60 times/hour
Model Variant:-2; 0 watchdog 1 domestic 2 residential
Timer override:-0; 0 to 60 minutes set to zero normal for operation



Note –

The device name, Installer name, Installer Contact details are also programmable up to 21 characters.

We recommend that these settings are suitable for most installations, but the system designer will still need to confirm, and the installer will still need to verify the operation.

3.10 Optional Features – Power Loss Alarm

Optional rechargeable NiMH battery can be fitted to provide an audible alarm in the event of a power failure (2.4V NiMH Rechargeable Battery Pack (700mAh) with lead).

Fit to J35 is (bottom RH corner), **RS Part number: 176-9373**

3.11 Annual service reminder (12 month)

At the end of every 12-month period the Service LED activates to remind the user that the unit is due its yearly service and BS 9251:2021 Annual Test. [Refer to sections 5.6 & 5.7](#)

3.12 Excessive pump operation / Leak detection (> 10 operations in a 7-day period)

If the pump activates more than ten times in any 7-day period, the system is deemed to have a leak and hence maintenance is required. The Fault Digital output and Fault LED will activate. [These can be reset after being attended to see section 3.5](#)

4.0 General information

4.1 Delivery and handling



The FireSAFE+ unit is supplied from the factory on a wooden pallet suitable only for handling by forklift equipment.

The weight and size of the FireSAFE+ unit may require the use of proprietary lifting equipment to be handled safely. Please observe the weight indicated on the box label before selecting lifting method. Do not stack items on top of the box. Do not drop the pallet. The weight of the unit is also available in the [Product range – Dimensions and Weights section 6.3](#).

4.2 Delivery inspection upon receipt

The FireSAFE+ should be immediately unpacked and inspected.



Any damage must be reported to the supplier within seven days in writing. It is important that this Installation and Operating manual is studied carefully before any installation takes place. The installation and operation should also be in accordance with local regulations and accepted codes of practice.



Under no circumstances should the unit be operated until correctly installed in the system pipework and ensure that the controller box cover and product cover are secured in their appropriate positions.

4.3 Warranty

1. The Grundfos warranty covers all defects within the FireSAFE+ originating from faulty workmanship and/or materials for a period of two years from the date of installation or thirty months from the date of dispatch from the factory, whichever is the shorter.
2. The warranty covers the replacement of any faulty parts and our labour cost to replace the faulty parts. It does not cover the cost of removing, returning, and refitting the FireSAFE+ unit or any secondary losses arising from the failure.
3. Under no circumstances should faulty equipment be dismantled. Failure to comply with this instruction could invalidate the warranty.
4. Defects arising from incorrect installation, installation outside temperature limits (+3°C to 40°C), water containing debris, water containing harmful chemicals, inadequate electrical protection, faulty ancillary equipment, lightning, or other circumstances beyond our control, are not covered by the warranty.

4.4 Site storage

It is strongly recommended once the FireSAFE+ unit has been delivered to site, that it is placed immediately into a dust, moisture and frost-free area which has been secured to prevent unauthorised interference.

4.5 Frost protection



The FireSAFE+ unit must be protected from freezing conditions. The unit may require trace heating or lagging. If the FireSAFE+ unit is being stored during periods of frost the whole unit should be drained to avoid damage. Remove all drain and vent plugs and allow the pump to drain. Do not replace the plugs until the FireSAFE+ unit is to be used again.



The pump must be vented/primed before it is started again. Loosen but do not remove the priming screw until water flows from the hole.

4.6 Operating environment



The FireSAFE+ unit must not be used in an environment which has been classified as hazardous where it could provide a source of ignition and therefore cause an explosion by flame path.

Grundfos do not accept any responsibility for the use of FireSAFE+ unit to pump liquids which could be construed as being hazardous to health either by touch, ingestion or inhalation of fumes or gases given off by the liquid.

4.7 Installation location

Careful consideration must be given to the location of the FireSAFE+ unit. The following are minimum requirements:



The FireSAFE+ unit should ideally be placed in a location where the Control panel LEDs can readily be seen, and the internal buzzer heard without obstruction.



These are primary warning and alarm events and should be available to be observed and heard. Additional system provision for alerting the inhabitants to the **FireSAFE+** warnings/alarm must also be made.



The FireSAFE+ also needs to be protected against the extremes of temperature during a Fire and during the winter. Provision to maintain the FireSAFE+ 's operating conditions needs to be made within the overall system design.



The FireSAFE+ unit should be sited in a dry, well ventilated, and frost-free position, where it will not be subjected to extremes of temperature.



The FireSAFE+ may be located outdoors in a weather, frost, and rodent proof enclosure with adequate ventilation especially during hot weather. All pipe work subject to freezing conditions must be adequately protected. Alternative system provision must be made for alerting the inhabitants to the FireSAFE+ warnings and alarms.



To enable maintenance and service of the FireSAFE+ unit to be carried out satisfactorily, the area should have adequate lighting for this work to be carried out safely.



Ensure that the FireSAFE+ is positioned to allow access for examination and service. A minimum of 50cm should be left all around the FireSAFE+ unit. Adequate drainage facilities and protection from water damage in the immediate vicinity of the FireSAFE+ unit must be provided.

The FireSAFE+ unit should not be installed in an unventilated small space, ensure adequate ventilation for the motor.

4.8 Break tanks and mains water connection



With the permission of the Water Utility company, it may be possible to connect the FireSAFE+ unit directly to the town water mains. A dedicated suction pipe will be required, the diameter of which should match the pump suction as an absolute minimum. Suitable backflow prevention devices as per byelaws should be included.

In situations where the town mains supply cannot be utilized directly it will be necessary to install a water storage tank (break tank) between the incoming mains water supply and the FireSAFE+ unit, it must however have a type AB Air Gap and be supplied and installed in accordance with the Water Byelaws Regulations.



Check that the water storage tank has adequate capacity to meet/exceed the demand. Refer to the standards requirements.

4.9 Installation - General requirements



The suction and discharge pipework must be at least the same size as the FireSAFE+ suction and discharge ports, as a smaller size may result in reduced pump performance or increased system resistance leading to a reduced flow.



The installation suction and discharge pipework should be properly supported before being connected to the FireSAFE+ unit so that the FireSAFE+ unit is not stressed.



The pipework installation to and from the FireSAFE+ unit should be in accordance with local water authority regulations, best industry practice and according to the design recommendations in BS 9251 latest revision.



The electrical installation of the FireSAFE+ unit should be in accordance with the latest issue of the I.E.E. regulations and according to BS 9251 latest revision.

4.10 Installation and commissioning recommendations

We recommend that System Design, Installation and Maintenance of FireSAFE+ unit should only be completed by Engineers holding UKAS accredited certification (FIRAS/LPCB/IFCC).



All electrical connections should be completed by a qualified and authorized electrician in accordance with the wiring diagram supplied within the control panel/this manual, the latest I.E.E. regulations and in accordance with BS9251 latest revision.



All mechanical connections should be completed by a qualified and authorized person in accordance with BS9251 latest revision and the relevant codes of practice.



The FireSAFE+ unit must be earthed.



Do not attempt to start the pump even to check the direction of rotation until the system has been filled with water and both the pump and the system have been primed/vented. Running the pump dry may permanently damage it. This will not be covered by warranty.



Do not remove the controller enclosures, controller components, motor terminal box cover, electrical cables, or any other electrical protective covering without first ensuring that the electrical supply is suitably isolated and cannot be switched back on.



Do not attempt to supply electricity to the controller/unit and run the pump electric motor without ensuring that all electrical fittings, cables, and enclosures are intact and suitably electrically isolated from human touch during operation.



Do not attempt to supply electricity to the electric motor or re-pressure the pipe work system without first ensuring that all protective coverings are held securely in their correct positions.

4.11 Pressure switch setting

The FireSAFE+ Pressure switches are factory set at 1 bar below the Closed Valve Pressure of the pump. The factory setting may not be ideal for the site application, this can be changed to suit. The operating range of the pressure switches are 0.7-14 Bar and 2-42 Bar.



An Insulated 5.5mm Nut Spinner should be used.

A Multi-meter can be used to verify status of switch position open/closed to show set point.

NOTE – Both pressure switches must be adjusted to same pressure.



Warning:

230V present behind pressure switch cover, ensure power is turned off.

Set point adjustment M3 Nylon Nut (5.5 Socket)

- Remove the four switch lid screws
- Remove the red electrical cover
- Tighten the nylon nut clockwise to reduce the pressure set point
- Loosen the nylon nut anticlockwise to increase the pressure set point

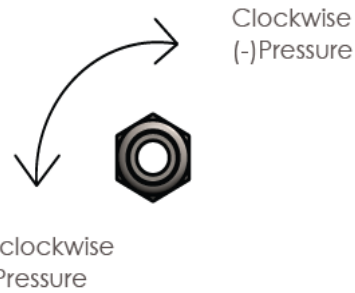
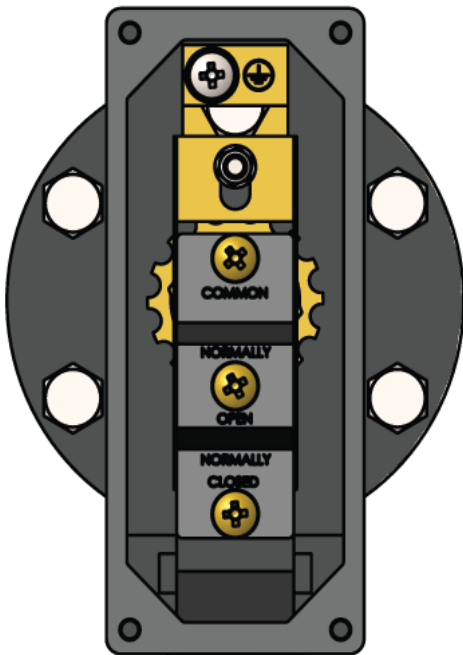

Reset point adjustment

Set the set point as above and then set the reset point as follows:

- Rotate the adjusting gear clockwise to reduce the pressure differential
- Rotate the adjusting gear anticlockwise to increase the pressure differential
- Always do one final check as sometimes the set point can move slightly when moving the wheel
- When the set point achieved replace the red cover and re-fit the lid
- Please write on the label the new set point and the re-set point

4.12 Electrical Connections

WIRING DETAIL FOR FIRESAFE+ RESIDENTIAL VARIANTS

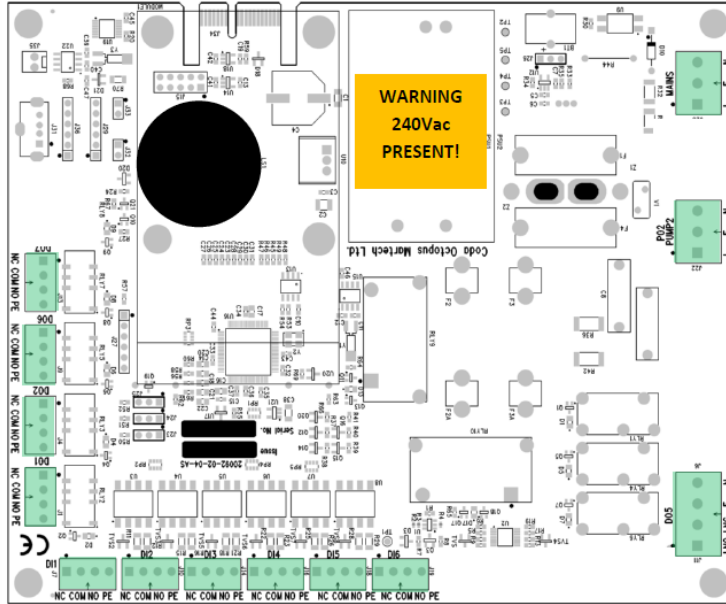

MAINS INPUT
240Vac, 15A

PUMP VIA
CONTACTOR
240Vac, 15A

WARNING: DO NOT OVER-TIGHTEN!
Power terminals 0.5Nm max. Overtightening may result in damage to the terminal

VALVE
N
E
LNO =
LNC =

- OUTPUTS, Volt free change-over contacts, max 5A ▼▼▼
- SPARE
Not used
 - LOW WATER ALARM Com-NO
Contact closes when Low Water detected
 - FAULT Com-NC
Contact open when no fault closes when fault detected or power failure
 - FIRE ALARM Com-NO
Contact closes when in Fire Mode

INPUTS, 12Vdc on COM terminal ▶▶▶

WARNING: DO NOT OVER-TIGHTEN!
Signal terminals 0.25Nm max. Overtightening may result in damage to the terminal

- PCB viewed when lid folded downwards for installation. Some circuit boards (PCB) may have additional components or connectors fitted, which are not used.
- FLOW SWITCH can be wired NC-COM where the flow switch opens on flow (closed when no flow is present).
Flow Switch Can also be wired NO-COM where the flow switch closes on flow. In this configuration, the COM-NC contacts must also be linked.
- MONITORED VALVE
Com-NC contact opens on low water
- PHASE MONITOR
Com-NC contact opens on low water
- WATER LEVEL
Com-NC contact opens on low water
- FLOW SW, see note
- PRESSURE SW2
As per P SW1
- PRESSURE SW1
Com-NC contact opens on low pressure

SENSOR WIRING DETAIL

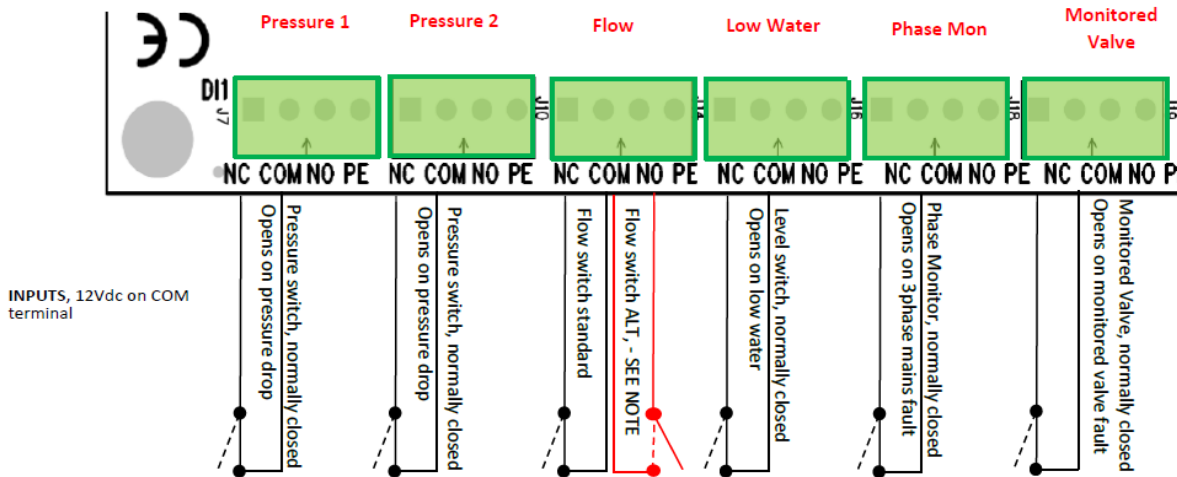

INPUTS, 12Vdc on COM terminal

NOTE

For correct operation and compliance with BS9251-2021, dual pressure sensors and a flow switch must be fitted.

If a Low Water sensor, Phase Monitor (3ph variants only) or Monitored Valve is not required, each input MUST be linked across to prevent alarms.

FLOW SWITCH input can be wired NC-COM where the flow switch opens on flow (closed when no flow is present).

Flow Switch input can also be wired NO-COM where the flow switch closes on flow. In this configuration, the COM-NC contacts must also be linked.



Digital Input and Output terminals are suitable for max. 0.5mm² cable.
Digital Inputs are wetted with 12V DC
Digital Output terminals are suitable for 5A max

5.0 Installation checklist

During the installation phase:



DO NOT apply main power to the unit.
DO NOT apply water to the unit.

Step	Done	Activity	Action/Check/Notes
1		Fully read and study this manual.	
2		Unpack, inspect for completeness and any damage.	<i>Report to supplier/customer Do not use.</i>
3		Ensure that the installation location meets all the requirements in this manual and the latest applicable Standard.	
4		Transport the unit to the chosen location.	<i>Caution - handling</i>
5		Test proposed location of unit for suitability, fit, access and ventilation.	
6		Make floor fixings.	<i>If required</i>
7		Locate unit and fasten down unit as required.	
8		Make the suction port connections to the water supply.	<i>Do not turn on water. Union type connection recommended</i>
9		Make the discharge port connections to the sprinkler riser.	<i>Do not turn on water. Union type connection recommended</i>
10		Make the Cooling line connections to drain or re-circulate to tank	
11		Loosen the four fixing screws and open the controller.	<i>Connection diagram found on back plate of the controller and in the I&O manual.</i>
12		Wire digital inputs from water tank and flow switch through controller box glands and to connector blocks on PCB (as required). Label wires. Perform continuity check.	<i>Connection diagram found on back plate of the controller and in the I&O manual. <u>Maximum wire CSA = 0.5mm²</u></i>
13		Wire digital outputs through controller cable gland and to connector blocks on PCB. Label wires. Perform continuity check.	<i>Connection diagram found on back plate of the controller and in the I&O manual. Caution – Ensure there are no voltages on the Digital input wires from other sources. <u>Maximum wire CSA = 0.5mm²</u></i>
14		Re-fit the controller back plate and front cover.	<i>Requires Torx T20 screwdriver</i>
15		Connect the other end of the electrical power cable to the mains power supply. This should be to a lockable isolator. Lock off the isolator to ensure mains power cannot be applied to the unit.	<i>Do not connect mains power to the unit Ensure mains power cannot be applied and is locked OFF. System must be earthed.</i>
16		Review all the above actions, if the commissioning phase does not follow immediately after, replace the front cover and screws. Leave the unit in a safe condition.	<i>Isolated Electrically and hydraulically.</i>
17		System is ready to be Commissioned.	

5.1 Commissioning checklist



Before the commissioning phase starts ensure that the **Installation checklist** has been completed and check the state of the mains power and water supplied to the unit.

Step	Done	Activity	Action/Check/Notes
1		Fully read and study this manual.	
2		Ensure that the installation location meets all the requirements in this manual and the latest applicable Standard.	
3		Check mains power and water to the unit are both OFF	<i>Ensure both are OFF and cannot be accidentally turned ON.</i>
5		Inspect the Installation, check everything in the Installation checklist has been completed.	<i>Check supply tank is full and the correct capacity.</i>
6		Check the factory setting of the pressure switch are according to the design calculations for the system. Make note of any differences for correction later.	<i>May require further adjustment against the pressure gauge later</i>
7		Close the system isolating valve on the discharge side of unit. Open the system isolating valve on the suction side of the unit. Apply water to the unit.	
8		Prime the CRi pump and the whole system as necessary. Open the discharge isolating valve. Inspect for leaks	<i>Refer to CRi pump I&O manual for guidance. Fix any leaks.</i>
9		Remove the controller front cover and check/inspect all supplementary wiring. If changing the settings, insert the USB stick with the settings file on. Refit the Back cover controller cover and review all the above actions. Apply the mains power. The controller will auto detect and apply the settings.	
10		Pump will start, run for 20 seconds, and pressurize the system. If necessary, prime/vent the system again. Check the pressure gauge value is as expected. Inspect for any leaks	<i>Fix any leaks</i>
11		Tune the pressure switch settings for the system against the gauge readings and the designed pressures settings by draining off water and allowing the unit to respond observing values on gauge.	
12		Check the digital inputs give the expected outputs <ul style="list-style-type: none"> • Tank low water level, Y / N <i>(Ring answer)</i> • Flow switch, Y / N <i>(Ring answer)</i> 	
13		Remove the USB stick. Replace front cover and re-fit the two screws	
14		Set the Auto Weekly Test time and Annual Service reminder	<i>See section 3.5 Button Press Functions</i>
15		Clean up area and ensure safe for user, Mains isolator is in the ON position, Isolating valves are in the OPEN position. Put system into Operation, Clear any faults.	<i>See section 3.5 Button Press Functions</i>
16		System is ready for Verification	<i>Update the history log at back of this manual</i>

5.2 System Verification checklist



Before the system is signed off and handed over to the customer the entire system needs to be performance verified.

Step	Done	Activity	Action/Check/Notes
1		Fully read and study this manual.	
2		Inspect the installation, check everything in the installation and commissioning check list has been completed.	
3		With the system active, pressurised and fault free.	
4		Partly open the FireSAFE+ drain point creating a very slow pressure drop	<i>Pressure maintenance function test</i>
5		Observe the pressure decaying and the point at which the system reacts on the pressure gauge.	<i>Check values against installation requirement. Change as necessary. Repeat as necessary.</i>
6		Close the drain point and seal the system. Observe the FireSAFE+ unit restoring the system pressure and returning to a healthy state after 20 seconds	<i>Observe screen and Controller LEDs</i>
7		Activate the Low water switch. Observe the LEDs on the front panel. Fault ON. This will activate after the Low water delay and will go OFF once the Low water switch signal has been stopped. Activate the Flow switch. Observe the LEDs on the front panel. Pump ON, Fire! ON. Press and hold the Reset button to stop	<i>Fire Alarm mode Continuous operation</i>
8		Check the Digital Inputs give the expected outputs when activated: <ul style="list-style-type: none"> • Fault Y / N (Ring answer) • Tank low water level Y / N (Ring answer) • Flow switch - Fire! Y / N (Ring answer) 	
9		Clear all active faults	<i>See section 3.5 Button Press Functions</i>
10		System should return to healthy operation state, Run Manual Test to check the Cooling line/Dump valve operation	<i>See section 3.5 Button Press Functions</i>
11		Insert the USB stick to record the system parameters. Check off all values and logs.	
12		Place the Pump off shut after fire activation sticker in a clearly visible location near or on the FireSAFE+ unit.	<i>Sticker included in document pack. Gives the user quick shut down instructions.</i>
14		Clean up area and ensure safe for user. Mains isolator is locked in the ON position. Isolating valves locked in the OPEN position.	<i>Inform customer and any monitoring services that the system is operational. Handover this manual.</i>
15		System is ready to use	

5.3 Operation

After completion of the **Installation, Commissioning** and **Verification** checklists the FireSAFE+ unit is ready for operation. The FireSAFE+ unit is designed for automatic operation with the minimum of user input.

The user does have the following option:

1 - Resetting of the weekly Auto test time to another more suitable time

See section 3.5 Button Press Functions

2 - Silencing the internal buzzer for service alarms

See section 3.5 Button Press Functions

3 – Following suppression and confirmation that the fire is out the FireSAFE+ unit can be stopped if the system pressure is restored to the set point

See section 3.5 Button Press Functions

4 – Putting the unit into Emergency start/Fire Mode

See section 3.5 Button Press Functions

Visual periodic inspection for Service and Fault LED is required.

5.4 User Inspection

It is the customer's responsibility to inspect the FireSAFE+ unit in addition to any service contract to ensure the safety and correct operation of the set during the interim period between service visits. The FireSAFE+ unit should be inspected at regular intervals of not more than six months.

This can be done by the user, following the checklist below.

The Record of the inspection should be added to the History Log at the back of this manual.

Step	Activity	Action/Check/Notes
1	Check that there are no leaks/corrosion from the system pipework. Inspect as far as reasonably possible.	<i>Report as necessary. Schedule maintenance</i>
2	Check the controller display Fault or Service LED is not lit.	<i>Refer to fault finding checklist. Schedule a service or maintenance visit.</i>

Any large deviations from the system designed settings should be investigated for possible faults. On the identification of any faults, check the symptoms with the fault-finding checklist first, and if necessary, contact the facilities manager or installer in the first instance.

Details may be found on the front of this manual and in the History log section.

5.5 User maintenance

There are **NO** user serviceable parts in the FireSAFE+ unit. Maintenance must be completed by suitably qualified and competent personnel.

5.6 Service & Annual test/Inspection

BS 9251:2021 recommends that the full fire protection system is tested and inspected every twelve months. This includes the FireSAFE+ unit and ensures that the system remains in first class working order.

The FireSAFE+ unit should be tested annually by a suitably qualified and competent person.

Following the below checklist gives some minimum activities that need to be completed at each service and annual test. Other activities will need completing according to the system design and any fault rectification required.

The record of the service should be added to the history log at the back of this manual.

Should any maintenance work be required then the water and electricity supply may require isolating prior to commencing work.



The building will be without the fire protection that the FireSAFE+ unit gives during this period and alternative measures should be considered. The owner of the building and any inhabitants should be informed of this.

Ensure any outgoing signals from the FireSAFE+ unit are not going to cause activation of:



- Fire alarms/beacons
- Fire alarm control panel
- Fire service response or fire monitoring service response
- Any other warning/monitoring devices installed (eg. SMS to mobile device)

Consideration should be given to contacting any response services beforehand and informing them of the Service and annual test activity of the FireSAFE+ unit.



Before removing the terminal box cover from the electric motor or before any removal/dismantling of the pump/motor unit takes place, ensure that the electricity supply to the control panel has been suitably isolated and cannot be switched on.



Once any maintenance work is completed, ensure that the isolating valves are opened fully, locked in the open position and that the electricity supply to the FireSAFE+ unit is restored, and locked in the ON position.

Check that the correct system pressure is achieved.

Inform the necessary people that the system has been restored.

5.7 Service & Annual test/Inspection checklist

Step	Done	Activity	Action/Check/Notes
1		Inspect the control panel for any LED Service/Fault indications. Clear all Service/Fault conditions first.	<i>Refer to the fault-finding checklist.</i>
2		TURN OFF - Follow a Safe Isolation Procedure before working on the unit.	
3		General inspection for loose fittings, pump fixings. General inspection for leaks, corrosion, and damage. Remove the two screws retaining front cover. Remove front cover. Place to one side.	<i>Do not disconnect earth wire to the front cover. Fix any leaks. Report any corrosion. For leaks from pump shaft seal. Refer to CRI pump I&O.</i>
4		Inspect all external electrical wiring for wear and tear, nicks, breaks, exposed conductors, and poor fitting/termination etc.	<i>Repair/replace as necessary.</i>
5		Inspect all internal electrical wiring for wear and tear, nicks, breaks, exposed conductors, and poor fitting/termination etc.. Check Pressure switch terminals for corrosion and connector fully engaged	<i>Repair/replace as necessary.</i>
6		Access the PCB controller and Inspect: PCB, fuses, and wiring.	<i>Repair any wiring. For fuses see spare parts list.</i>
7		Perform Annual system test.	<i>As per BS 9251 requirements.</i>
8		Check unit responds to pressure drop, and enters: <ul style="list-style-type: none"> • System pressure maintenance mode (Jockey Mode) • Possible Fire mode Check Flow switch enables <ul style="list-style-type: none"> • Fire Mode 	<i>See section 3.5 To exit fire mode, restore system pressure and hold up and down button.</i>
9		<ul style="list-style-type: none"> • Check the digital Inputs give the expected outputs when triggered. • Low Water • Fire! 	
10		Perform Manual Auto Test	
11		Perform Flow and Pressure test	
12		With the USB stick take a copy of the unit log files and inspect.	
13		Inspect for leaks and repair	<i>Fix any leaks.</i>
14		Review all the above actions then follow the Safe Isolation Procedure for	
15		Pump will start, run for 10 seconds, and pressurize the system. If necessary, prime the system again. Check the pressure gauge value is as expected.	<i>Press Reset button if the excessive start's fault appears. See section 3.5</i>
16		Set the pump test time. If desired.	
17		Clean up area and ensure safe for user, Mains isolator is locked in the ON position Isolating valves locked in the OPEN position	<i>See section 3.5</i>
18		Clean up area and ensure safe for user.	
19		System is ready to operate.	<i>Update history log at back of this manual. Inform customer that the system is operational. Handover this manual.</i>

6.0 Technical Information

6.1 Product Range – Electrical Requirement

1 PHASE - 220-230V 1ph 50Hz

Model	POWER (KW)	STARTING CURRENT (Amps)	FULL LOAD CURRENT (Amps)	STARTER TYPE	PUMP SET PRODUCT CODE
CRi 5-5	0.75	11.8	1.9	DIRECT ONLINE	92856363
CRi 5-12	2.20	46.2	14	DIRECT ONLINE	92856365
CRi 5-15	2.20	46.2	14	DIRECT ONLINE	92856369
CRi 10-3	1.1	28.9	7.4	DIRECT ONLINE	92856391
CRi 10-4	1.5	38.6	9.9	DIRECT ONLINE	92856392
CRi 10-5	2.2	46.2	14	DIRECT ONLINE	92856393
CRi 10-6	2.2	46.2	14	DIRECT ONLINE	92856395

3 PHASE - 380-415V 3ph 50Hz

Model	POWER (KW)	STARTING CURRENT (Amps)	FULL LOAD CURRENT (Amps)	STARTER TYPE	SOFT START CURRENT (Amps)	STANDARD PUMP SET PRODUCT CODE	SOFT-START PUMP SET PRODUCT CODE
CRi 10-6	2.2	42.3	4.6	DIRECT ONLINE	16.9	92856400	92856444
CRi 10-7	3.0	58.0	6.3	DIRECT ONLINE	23.2	92856402	92905648
CRi 10-8	3.0	58.0	6.3	DIRECT ONLINE	23.2	92856404	On req.
CRi 10-9	3.0	58.0	6.3	DIRECT ONLINE	23.2	92856405	On req.
CRi 10-10	4.0	87.7	7.9	DIRECT ONLINE	35.1	On req.	On req.
CRi 10-12	4.0	87.7	7.9	DIRECT ONLINE	35.1	On req.	92856451
CRi 10-14	5.5	129.8	11.0	DIRECT ONLINE	51.9	On req.	On req.
CRi 15-2	2.2	42.3	4.6	DIRECT ONLINE	16.9	On req.	On req.
CRi 15-3	3.0	58.0	6.3	DIRECT ONLINE	23.2	92856409	On req.
CRi 15-4	4.0	87.7	7.9	DIRECT ONLINE	35.1	92856410	On req.
CRi 15-5	4.0	87.7	7.9	DIRECT ONLINE	35.1	92856411	On req.
CRi 15-6	5.5	129.8	11.0	DIRECT ONLINE	51.9	92856412	92856457
CRi 15-7	5.5	129.8	11.0	DIRECT ONLINE	51.9	92856413	on req.
CRi 15-8	7.5	131.0	14.4	DIRECT ONLINE	52.4	92856414	92856461
CRi 15-9	7.5	131.0	14.4	DIRECT ONLINE	52.4	On req.	On req.
Cri 15-12	11,0	N/A	20.3	SOFT-START	58.5	N/A	92856468
CRi 20-7	7.5	131.0	14.4	DIRECT ONLINE	52.4	92856442	On req.
CRi 20-10	11,0	N/A	20.3	SOFT-START	58.5	N/A	92856465
CRi 20-17	18.5	N/A	33.5	SOFT-START	120.6	N/A	92856470

6.2 Product Range – Pressures and Flows (consult Product Data sheets for Pump curves)

1 PHASE - 220-230V 1ph 50Hz

Model	Nominal Head (Bar)	Nominal Flow (L/Min)	Closed Valve (Bar)
CRi 5-5	2.13	5.8	3.14
CRi 5-12	5.44	5.8	7.83
CRi 5-15	6.62	5.8	9.71
CRi 10-3	21.9	166.7	2.94
CRi 10-4	29.2	166.7	3.91
CRi 10-5	36.8	166.7	4.9
CRi 10-6	42.9	166.7	5.83
CRi 15-2	20.2	283.33	2.75

3 PHASE - 380-415V 3ph 50Hz

Model	Nominal Head (Bar)	Nominal Flow (L/Min)	Closed Valve (Bar)
CRi 10-6	4.74	166.7	6
CRi 10-7	5.61	166.7	7.03
CRi 10-8	6.35	166.7	8.01
CRi 10-9	7.1	166.7	9
CRi 10-10	8.0	166.7	10
CRi 10-12	9.5	166.7	11.96
CRi 10-14	11.2	166.7	14.02
CRi 15-2	2.2	283.3	2.81
CRi 15-3	3.25	283.3	4.18
CRi 15-4	4.39	283.3	5.57
CRi 15-5	5.43	283.3	6.92
CRi 15-6	6.6	283.3	8.3
CRi 15-7	7.6	283.3	9.66
CRi 15-8	8.8	283.3	11.08
CRi 15-9	9.9	283.3	12.45
CRi 15-12	13.3	283.33	16.57
CRi 20-7	9.9	350	10.1
CRi 20-10	11.6	350	14.51
CRi 20-17	19.9	350	24.71

6.3 Product Range – Overall Dimensions and Weights

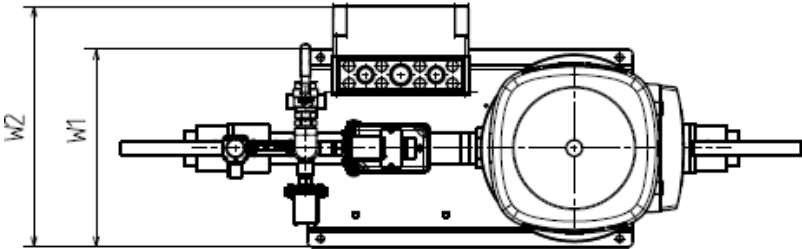
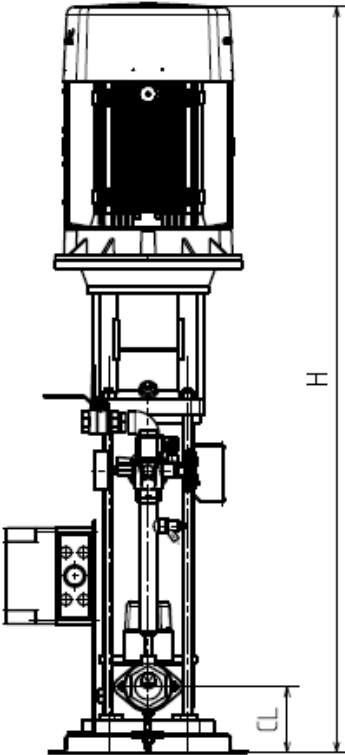
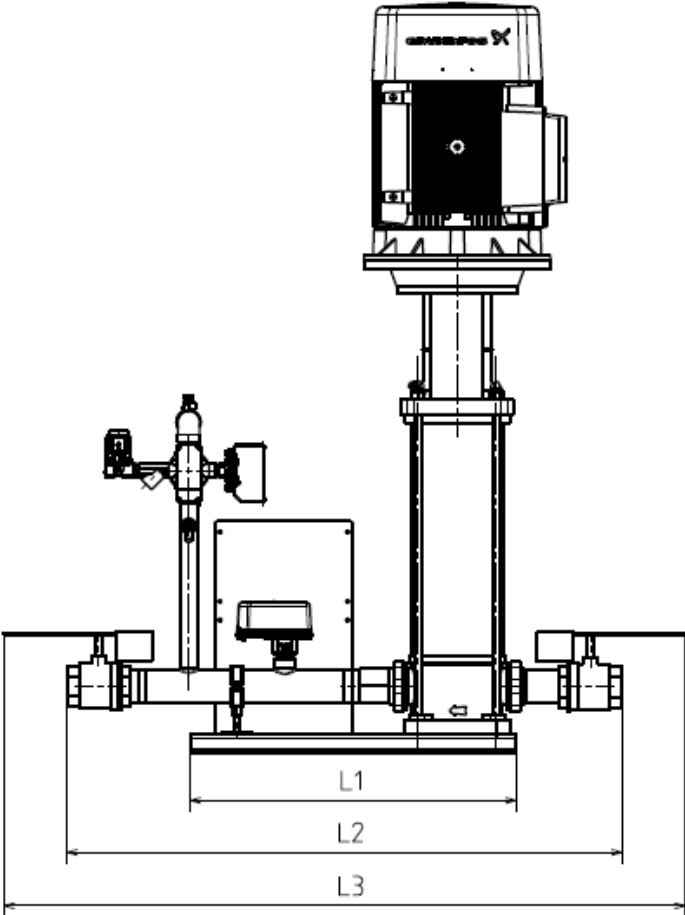

1 PHASE - 220-230V 1ph 50Hz

Model	LENGTH			WIDTH	HEIGHT	PIPEWORK CENTRELINE HEIGHT	SUCTION DIAMETER	DELIVERY DIAMETER	UNIT WEIGHT	PUMP SET PRODUCT CODE
	L1 (mm)	L2 (mm)	L3 (mm)							
CRi 5-5	610	930	1120	370	612	82	1.25"	1.25"	80	92856363
CRi 5-12	610	930	1120	370	908	82	1.25"	1.25"	98	92856365
CRi 5-15	610	930	1120	370	988	82	1.25"	1.25"	100	92856369
CRi 10-3	610	987	1218	370	714	113	1.5"	1.5"	74	92856391
CRi 10-4	610	987	1218	370	784	113	1.5"	1.5"	76	92856392
CRi 10-5	610	987	1218	370	814	113	1.5"	1.5"	81	92856393
CRi 10-6	610	987	1218	370	844	113	1,5"	1,5"	82	92856395
CRi 15-2	610	1049	1285	370	776	123	2"	2"	83	92856399

3 PHASE - 380-415V 3ph 50Hz

Model	LENGTH			WIDTH			HEIGHT	PIPEWORK CENTRELINE HEIGHT	SUCTION DIAMETER	DELIVERY DIAMETER	UNIT WEIGHT		STANDARD PUMP SET PRODUCT CODE	SOFT-START PUMP SET PRODUCT CODE
	L1 (mm)	L2 (mm)	L3 (mm)	W1 (mm)	DOL W2 (mm)	SOFT START W2 (mm)					DOL (KG)	SOFT START (KG)		
CRI 10-6	610	987	1218	370	450	511	844	113	1.5"	1.5"	81	87	92856400	92856444
CRI 10-7	610	987	1218	370	450	511	893	113	1.5"	1.5"	87	93	92856402	92905648
CRI 10-8	610	987	1218	370	450	511	923	113	1.5"	1.5"	88	94	92856404	On req.
CRI 10-9	610	987	1218	370	450	511	953	113	1.5"	1.5"	89	95	92856405	On req.
CRI 10-10	610	987	1218	370	450	511	1020	113	1.5"	1.5"	102	108	On req.	On req.
CRI 10-12	610	987	1218	370	450	511	1080	113	1.5"	1.5"	104	110	On req.	92856451
CRI 10-14	610	987	1218	370	450	511	1191	113	1.5"	1.5"	123	129	On req.	On req.
CRI 15-2	610	1049	1285	370	450	511	774	123	2.0"	2.0"	85	91	On req.	On req.
CRI 15-3	610	1049	1285	370	450	511	840	123	2.0"	2.0"	88	94	92856409	On req.
CRI 15-4	610	1049	1285	370	450	511	922	123	2.0"	2.0"	101	107	92856410	On req.
CRI 15-5	610	1049	1285	370	450	511	967	123	2.0"	2.0"	103	109	92856411	On req.
CRI 15-6	610	1049	1285	370	450	511	1063	123	2.0"	2.0"	121	127	92856412	92856457
CRI 15-7	610	1049	1285	370	450	511	1108	123	2.0"	2.0"	122	128	92856413	on req.
CRI 15-8	610	1049	1285	370	450	511	1141	123	2.0"	2.0"	134	140	92856414	92856461
CRI 15-9	610	1049	1285	370	450	511	1184	123	2.0"	2.0"	135	141	On req.	On req.
Cri 15-12	610	1049	1285	370	N/A	511	1499	123	2.0"	2.0"	N/A	191	N/A	92856468
CRI 20-7	610	1039	1275	370	450	511	1018	123	2.0"	2.0"	123	129	92856442	On req.
CRI 20-10	610	1039	1275	370	N/A	511	1411	123	2.0"	2.0"	N/A	188	N/A	92856465
CRI 20-17	610	1049	1275	370	N/A	511	1770	123	2.0"	2.0"	N/A	228	N/A	92856470

7.0 Spare Parts

Contact Grundfos Service for spare parts and advice regarding the FireSAFE+.

7.1 De-commissioning, Dismantling and Disposal

The building will be without the Fire protection that the FireSAFE+ unit gives once decommissioned and an alternative measure to provide protection against fire should be considered. The owner of the building, insurer and any inhabitants must be informed of this.

7.2 De-commissioning

De-commissioning is the process of taking out of service the FireSAFE+ unit. Reasons for this could be:

- Replacing with another unit
- Upgrading the unit
- Removing the system altogether

7.3 Dismantling



Always make sure that adequate provision is made to capture any water drained from the system and **FireSAFE+ unit** when dismantling.



Always make sure that adequate water spill protection for flooring etc is in place before dismantling and draining any part of the system or FireSAFE+ unit.

Appropriate PPE must be worn:



- Foot Protection – Safety Boots. EN ISO 20345:2011
- Eye Protection – Safety glasses. EN166-1F
- Basic Hand Protection – Gloves. EN388

Ensure any outgoing signals from the FireSAFE+ unit are not going to cause activation of:



- Fire alarms/beacons
- Fire alarm control panel
- Fire service response or fire monitoring service response
- Any other warning/monitoring devices installed (eg. SMS to mobile device)

Consideration should be given to contacting any response services beforehand and informing them of the de-commissioning and dismantling of the FireSAFE+ unit.

- ❑ Isolate the electrical supply ensuring it cannot be turned back on
- ❑ Disconnect the electrical supply from the FireSAFE+ unit
- ❑ Hold the OK button on the control panel to silence the internal buzzer
- ❑ Close the system isolating valve on the suction side of the FireSAFE+ unit
- ❑ The sprinkler system may still be pressurised from the FireSAFE+ internal non- return valve to the sprinkler head. Drain the water from the system from the system drain point; beware of pressure in the system. Close the system isolating valve on the discharge side of the FireSAFE+ unit
- ❑ Drain the FireSAFE+ unit and system pipework from the point chosen to disconnect the FireSAFE+ unit on the suction side of the unit
- ❑ Drain the FireSAFE+ unit by removing the drain point
- ❑ Dismantle the pipework and base fixings
- ❑ Remove the set with appropriate handling equipment and procedures

7.4 Disposal

The **FireSAFE+ unit** has valuable recyclable components.

Disposal of this product or parts of it must be carried out according to the following guidelines:

- ❑ Use the local public or private waste collection service.
- ❑ The materials/components used need to be segregated according to the disposal receivers' requirements.
- ❑ In case such waste collection services do not exist or cannot handle the materials used in the product, please deliver the product or any hazardous materials from it to your nearest Grundfos company or service workshop.

Local and National environmental legislation must always be complied with.

8.0 Fault finding checklist

Faults will be visually shown on controller and the light sequences below:

Fault event	Fault Detected and Remedy
Screen Not Visible and Power LED not illuminated.	No Power to the unit. Check power to unit and protective devices. Controller fuse has blown. Check cause of fuse blowing and remedy
Fault LED Flashing 2 times	Auto Test Failure One of the pressure switches has not activated or de-activated. Pump could not restore the pressure within the given time period. For more specific details take a copy of the logs files and interrogate.
Fault LED Flashing 3 times	Low Water Signal Low water level in tank has been detected or the Low water input is not being used and has not been linked out. Investigate both.
Fault LED Flashing 4 times	Pressure switch 1 Failure During Auto test Pressure switch 1 failed. Investigate the cause of failure, could be the wait time is not long enough or the switch has failed. Repair/Adjust program or replace switch.
Fault LED Flashing 5 times	Pressure switch 2 Failure During Auto test Pressure switch 2 failed. Investigate the cause of failure, could be the wait time is not long enough or the switch has failed. Repair/Adjust program or replace switch.
Fault LED Flashing 6 times	Excess Consumption/leak Pump starts has exceeded the weekly amount that the unit has been programmed too. Check the reason for the excessive starts and remedy or increase the number of
Fault LED Flashing Nine times	Cooling line failure During Auto test neither Pressure switches activated. Check Cooling line fuse and programmed open time. Check wiring. For more specific details take a copy of the logs files and
Service LED ON	12-month Service due. Perform 12-month Annual Inspection and Test. Reset Service counter.

The Digital outputs (D01/D02/D03) represent the following information:

Digital Output	Fault detected
D01	Fire Alarm device (system flow switch) has been activated.
D02	Fault detected by the controller refer to the checklist above. LED coding will describe fault found. <i>See section 3.6</i>
D03	Low water low level device (level switch in break tank) has been activated.

System operation problems can be diagnosed using the following checklist:

Fault	Possible cause(s)	Corrective Action(s)
Pump does not run when "Manual run" "Start Fire mode" "start weekly test" buttons are pressed	<ol style="list-style-type: none"> 1) No electrical supply to Pump/FireSAFE+ control panel. 2) Pump fuse blown. 3) Controller fuse blown. 4) Faulty Controller. 5) Power wiring to pump/controller. 	<ol style="list-style-type: none"> A) Check power LED ON. B) Check Fault LED, refer to above coding table. C) Check electrical supply to pump. D) Contact your system supplier/Grundfos Service for remedial action.
Pump does not reach the duty point but continues to run	<ol style="list-style-type: none"> 1) Not enough water getting to the pump. 2) Air trapped in pump and or system. 3) Small demand from system or leak. 4) Pressure switch value(s) set to high. 	<ol style="list-style-type: none"> a) Check suction isolating valve is fully open. b) Bleed air from system and pump. c) Check system for demand/leak. d) Contact your system supplier/Grundfos Service for remedial action.
Pump does not reach the duty point while running and shuts off	<ol style="list-style-type: none"> 1) Pressure switch setting too low. 2) Pressure switch fault. 	<ol style="list-style-type: none"> a) Check settings of the pressure switches are not too low. b) Replace pressure switch. c) Check unit is suitable for duty point required. d) Contact your system supplier/Grundfos Service for remedial action.
Pump delivers correct pressure but does not stop with no demand	<ol style="list-style-type: none"> 1) Pressure switch setting too high. 2) Pressure switch fault. 3) Demand from system/leak. 4) Pressure vessel settings (if used). 5) NRV not sealing properly. 	<ol style="list-style-type: none"> a) Check settings of the pressure switch are not too high. b) Replace pressure switch. c) Inspect system. d) Check vessel pre-set pressure. e) Contact your system supplier/Grundfos Service for remedial action.
Pump does not run	<ol style="list-style-type: none"> 1) Pressure switch not giving signal to PCB. 2) Pump fault. 	<ol style="list-style-type: none"> a) Check connections at pressure switch ends and PCB. b) Check wire for shorts. c) Check Pressure switches are wired into the correct PCB terminals.
Pump does not start Alarm! LED ON Buzzer ON	<ol style="list-style-type: none"> 1) Pump fault. 2) Wiring fault. 	<ol style="list-style-type: none"> a) Check pump and pump fuse. b) Check pump wiring.
Possible Fire Mode engaged, pump on but no sprinkler head activated	<ol style="list-style-type: none"> 1) Leak in system great enough to cause pressure drop and engage Possible Fire Mode. 	<ol style="list-style-type: none"> a) Find and fix leak. b) Reset system.

9.0 History log

Date	Activity and notes (Install, Commission, Verification, Inspection, Service, Fault, Recommendations)	Who / Contact details
	<div style="display: flex; justify-content: space-between;"> <div style="width: 40%;"> <p>Installed date <input style="width: 100%;" type="text"/></p> <p>Commissioned date <input style="width: 100%;" type="text"/></p> <p><u>Commissioned settings</u></p> <p>Designed set pressure = <input style="width: 50%;" type="text"/> Bar</p> <p>Actual set pressure = <input style="width: 50%;" type="text"/> Bar</p> <p>Pressure Switch settings = <input style="width: 50%;" type="text"/> Bar</p> <p>Low water level Input used = <input style="width: 50%;" type="text"/> Y/N</p> <p>Size of tank = <input style="width: 50%;" type="text"/> L</p> <p>Connected to Alarm panel = <input style="width: 50%;" type="text"/> Y/N</p> <p>Connected to Siren/buzzer = <input style="width: 50%;" type="text"/> Y/N</p> <p>Connected to Monitoring Service = <input style="width: 50%;" type="text"/> Y/N</p> </div> <div style="width: 55%;"> <p>Monitoring Service No. <input style="width: 100%;" type="text"/></p> <p>Other <input style="width: 100%;" type="text"/></p> <p>Other <input style="width: 100%;" type="text"/></p> </div> </div>	
01.01.2023	Make activity notes here	A. Smith ABCD Fire ltd Tel: 0123 456 7890

UKCA Declaration of Conformity

We, **Grundfos**, declare under sole responsibility that the products to which the declaration below relates, is in conformity with the UK regulations, standards and specifications to which conformity is declared, as listed below:

Valid for Grundfos products: **FireSAFE+**

- **Supply of Machinery (Safety) Regulations 2008/1597**
Standards used: BS EN ISO 12100:2010
Standards used: BS EN 809:1998+A1:2009
- **Electrical Equipment (Safety) Regulations 2016/1101**
Standard used: BS EN 60335-1:2012+A15:2021
Standard used: BS EN 60335-2-41:2003+A2:2010
- **Electromagnetic Compatibility Regulations 2016/1091**
Standard used: BS EN 55014-1:2017+A11:2020, BS EN IEC 55014-2:2021
Standard used: BS EN IEC 61000-3-2:2019+A1:2021, BS EN 61000-3-3:2013+A2:2021
Standard used: BS EN 61000-6-1:2007, BS EN 6100-6-3:2007+A1:2011
- **Restriction of the Use of Certain Hazardous Substances in Electrical and Electronic Equipment Regulations 2012/3032**
Standard used: BS EN IEC 63000:2018

The Grundfos **FireSAFE+** range is designed to comply with the recommendations of Standards *BS 9251:2021, EN16925: 2018 and LPS1667 (pre-release)*

This UKCA declaration of conformity is only valid when accompanying Grundfos instructions (Publication number **92914802**).

Bjerringbro, 02/03/2023

Signature



Ryan Appleby
Engineering Manager
Grundfos Holding A/S.
Poul Due Jensen Vej 7
DK-8850 Bjerringbro, Denmark.

Manufacturer and person empowered to sign the UKCA Declaration of Conformity.

If further details are required, please contact the Grundfos offices listed on the back page of these instructions.

CE EU Declaration of Conformity

We, **Grundfos**, declare under sole responsibility that the product **FireSAFE+**, to which the declaration below relates, is in conformity with Union harmonisation legislation, standards and specifications to which conformity is declared, as listed below:

- **Machinery Directive (2006/42/EC)**
Standards used: EN ISO 12100:2010
Standards used: EN 809:1998+A1:2009
- **Low Voltage Directive (2014/35/EU)**
Standard used: EN 60335-1:2012+A14:2019
Standard used: EN 60335-2-41:2003+A2:2010
- **EMC Directive (2014/30/EU)**
Standard used: EN 55014-1:2017+A11:2020, EN 55014-2:1997/A2:2008
Standard used: EN 61000-3-2:2014, EN 61000-3-3:2013
Standard used: EN 61000-6-1:2007, EN 6100-6-3:2007/A1:2011
- **Restriction of the Use of Certain Hazardous Substances in Electrical and Electronic Equipment Regulations (2011/65/EU and 2015/863/EU)**
Standard used: EN IEC 63000:2018

The Grundfos FireSAFE+ range is designed to comply with the recommendations of Standards *BS 9251:2021, EN16925: 2018 and LPS1667 (pre-release)*

This EU declaration of conformity is only valid when accompanying Grundfos safety instructions (Publication number **92914802**).

Bjerringbro, 02/03/2023

Signature:



Ryan Appleby
Engineering Manager
Grundfos Holding A/S.
Poul Due Jensen Vej 7
DK-8850 Bjerringbro, Denmark.

Manufacturer and person empowered to sign the EU Declaration of Conformity.

If further details are required, please contact the Grundfos offices listed on the back page of these instructions.

Service and Spare parts

Grundfos Service

Ltd Beswick
House, Greenfold
Way, Lancashire.
WN7 3XJ.

Service, Telephone: 01942 263 628
Service, email: servicesupportuk@grundfos.com
Technical Assistance, Telephone: 01525 850 000

Part number and description for this manual

Part no: **92941582** – Installation and Operating Manual – **FireSAFE+**

ECM: 1364420 dd 23/04/2023 Rev. 1.0

It is the continuing policy of Grundfos to develop and improve our products, and we reserve the right to amend prices and specification without prior notice.

be
think
innovate

GRUNDFOS 