

Specialist Products for
Fire Sprinkler Installations



Where Are We Installed?

Sale Engineering Products could be one of the most important names hidden from public view. Some of the biggest brands - both UK and global - entrust the care of their people and assets to us as part of their fixed fire protection systems. Just a few of them are...



contents

Where Are We Installed?.....	2	Pump Initiation Boards (wet riser).....	18
Introduction.....	4	Pump Initiation Boards (sprinkler).....	19
COMMERCIAL FLOW SWITCH TESTING			
ZONE GUARDIAN.....	6	False/Alarm Valve Booster Pumps.....	20
Flow Test Assemblies.....	8	Dry Riser Test Pump.....	22
DRY/PRE-ACTION SYSTEMS (AIR)			
Compressor Introduction.....	9	RESIDENTIAL & DOMESTIC	
Compact Compressors.....	10	Residential & Domestic Pumps.....	24
Ultra-Quiet Oil-Free Compressors.....	11	Priority Demand Valves.....	26
Belt-Driven Compressors.....	12	Residential Risers/Valve sets.....	28
Duplex Compressors.....	13	Monitored Ball Valves.....	29
Air Drying Equipment.....	14	ZONE GUARDIAN Residential.....	30
Pressure Maintenance.....	15	MISCELLANEOUS	
Off-the-shelf Compressors.....	16	Pressure Gauges.....	31
COMMERCIAL PUMP EQUIPMENT			
Jockey Pumps.....	17	Valves.....	32
		Accessories & Spares.....	33
		Pressure Switches.....	34
		Where Are We Installed?.....	35



w: www.firesprinkler.co.uk

t: +44 161 428 1180

e: info@saleengineering.co.uk

 @SaleEngineerPro

 Sale Engineering Products Limited

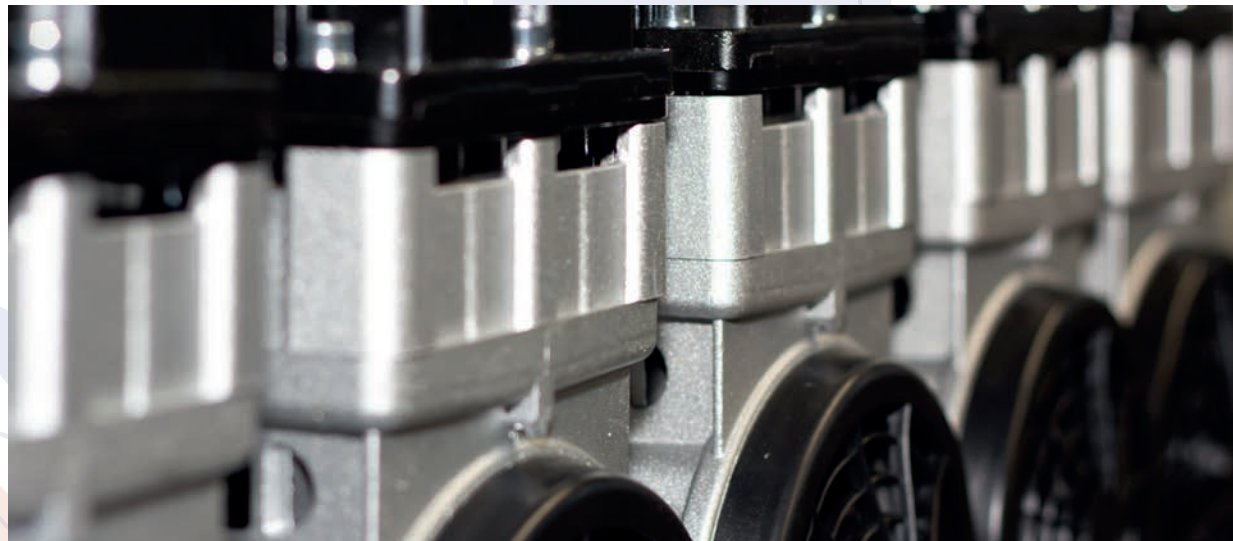



From then to now - the story of SEP

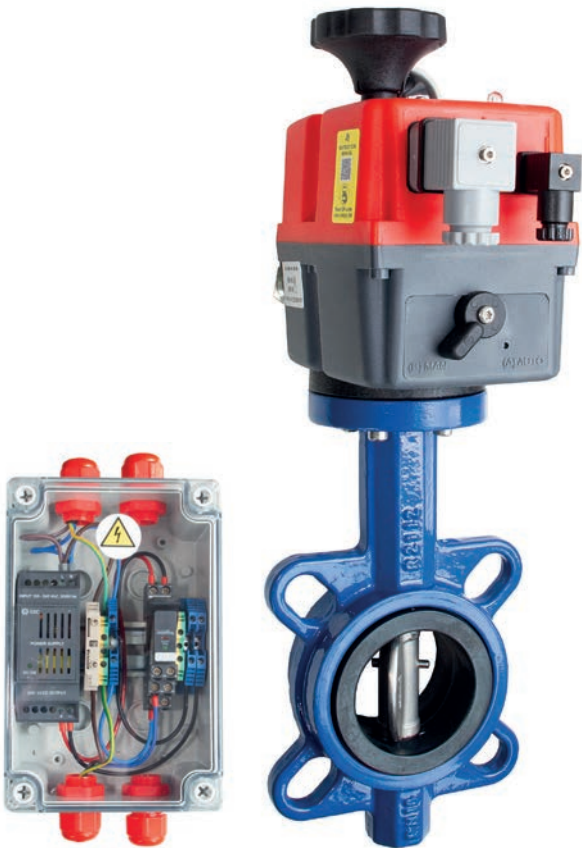

Our Beginnings: In the 1980s, Sale-based engineer David Birch had a brilliant idea. After spending many years building pipework on-site for the fire protection industry, he envisaged a way for the industry's installers to save time and money by using factory pre-fabrication techniques in a more efficient, professional way. As with all the best innovative ideas, it was simple.

And it was this simple idea that laid the foundations for Sale Engineering Products (now 'SEP') to be established in the early 1990s. From its early beginnings in borrowed garage space, the company expanded into its own workshop in 1995, and moved again in 2010 to larger premises in Cheadle, south of Manchester.

Since acquisition in 2014, the company has entered the next phase of its growth under the management of Rob Bell, a business professional having over 30 years' experience within engineering, manufacturing and projects. Relocating to even larger premises (still in Cheadle) in 2017 in order to cope with ever-increasing demand and the launch of our first ever LPCB-approved product, SEP continues to go from strength to strength.

Frustrated with running out of space (again!), and to remove the risks of unsecured tenancy, we invested in our own premises in 2022, giving us both security and plenty of room for growth – still in our new hometown of Stockport, south-east of Manchester.

Our Offering: We believe that the range and quality of products we offer, supported by our customer service and flexible skilled workforce, is unique.

Well-established as one of the UK's most respected manufacturers and suppliers of specialist products for the fire sprinkler industry, SEP's portfolio includes:

- Air compressors of various types for use on dry, alternate, tail-end or pre-action systems – specifically designed to meet industry guidelines including LPCB, FM and NFPA;
- Water flow alarm switch test devices, especially the LPCB- and FM-approved ZONE GUARDIAN;
- Pump initiation/test boards for both fire sprinkler and wet riser systems;
- Alarm valve (or false alarm) booster pumps for use on mains pressure-fed systems and;
- An ever-growing range of products for domestic and residential fire sprinklers including booster pump sets, priority demand valves and monitored valves; plus
- An almost limitless range of bespoke assemblies, designed and manufactured to solve our customers' challenges.



SEP also manufactures and supplies a large range of spares and accessories including jockey & booster pumps, off-the-shelf compressors, pressure gauges, pressure switches, valves of every type, orifice plates, flow meters and custom-built pipework.

We are often challenged to source all manner of difficult and obscure items, using our expertise and many contacts to succeed.

Although we are growing rapidly, we are still proud to be a small company with a dedicated, skilled and experienced workforce. This gives us our ability to react quickly and professionally to customer requirements, many of which go way beyond our 'catalogue'.

Our Ethos: Responsive, Flexible and always High Quality. That's our promise to our customers.

- We will always **respond quickly** to enquiries, questions and requests. And by quickly we mean hours, often minutes, but never days.
- **Flexibility** means having a 'YES we can' attitude. Give us a problem and we'll create a solution, with you and for you, that works.
- **High quality** has always been at the heart of everything we do. We are ISO9001 certified with annual audits by TUV, the UKAS accredited certification body.



Our Future: Our plans for the future are exciting. We continue to drive product development and geographic expansion, always taking our lead from our customers. You'll continue to see positive changes, and these will lead to even better products and even better customer service.

Since our previous brochure we have improved and expanded our range of compressors (including ultra-quiet and mid-range units), and launched several entirely new products such as priority demand valves and monitored ball valves.

We're constantly improving and, where appropriate, adding to our expansive fire protection product range. From online to on-site, SEP is still a traditional company, but one that's prepared for the future and for further success.

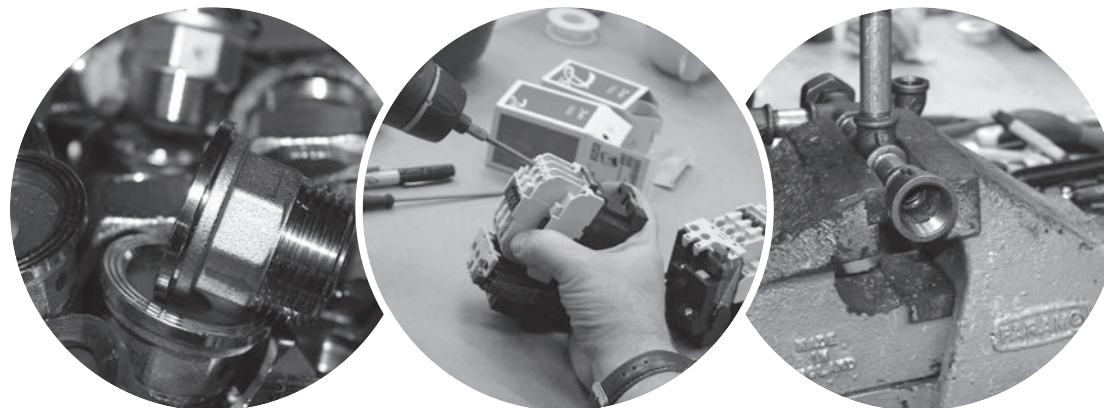



Zone Guardian



Sale Engineering Products is excited to be able to supplement its traditional Flow Test Assembly range with the more advanced ZONE GUARDIAN. This product is both LPCB and FM approved and is UKCA/CE-marked.

The ZONE GUARDIAN allows the mandatory quarterly testing of a wet-pipe fire sprinkler system's waterflow detector (flow switch) to be carried out remotely, saving significant volumes of water, and both time and cost for end-users and fire sprinkler maintenance contractors.

The unit ensures zero water wastage by the use of an artificial water flow created using a high-efficiency self-venting circulator pump manufactured by Grundfos, a global supplier.

ZONE GUARDIAN is available in pipe sizes from 2"/50mm up to 6"/150mm and includes - as well as the circulator pump - a Potter VSR vane-type flow switch and ball valves for vent, test and pump isolation, all mounted on 450mm long BS EN 10255 powder-coated pipe with grooved connections.

The assembly may be installed either horizontally or vertically.

An electronic key-operated test module is included to allow testing of both the local and any interconnected waterflow detectors.

Options include left- or right-hand orientation, retro-fit kits, custom colours - in fact, as standard with SEP, just call us and if it's possible we'll endeavour to do it for you.

We are confident that our new ZONE GUARDIAN, backed up by SEP's history of providing quality products to the market and of course two independent approvals, provides a viable alternative to the fire sprinkler industry.

ZONE GUARDIAN is also stocked by and available through our UK-exclusive distributor, Zeffire Ltd, as well as directly from SEP.



For overseas markets we have several exclusive distributors in place (please ask for latest details), otherwise please contact us to discuss direct purchase.



Specification:

Pressure rating: 12 bar (175psi)

Pipe sizes: 2"/50mm, 2 1/2"/65mm, 3"/80mm, 4"/100mm, 6"/150mm

Approvals: LPCB Cert Ref: 1423a/01
FM Approvals PR450692

Flow switch (Potter VSR-EU):

Trigger flow rate: 38lpm with up to 30s retard

Enclosure rating: IP54

Contact rating: 10A @ 125/250VAC; 10mA @ 24VDC



Circulator Pump:

Voltage: 230VAC 50Hz

Power: 60W max

Current: 0.58A max

Test module:

Surface-mounted, key-operated multi-function

Voltage in: 230VAC 50Hz

Voltage out: 230VAC 50Hz (local) or 24VDC (interconnect)

LEDs: Green: power/standby; Amber: test in progress; Red: flow switch active

IP rating: 56

Dimensions & Weights

PLAN (right-handed)

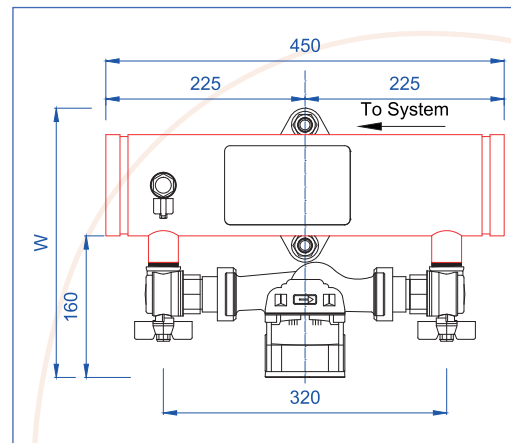

FRONT ELEVATION (right-handed)

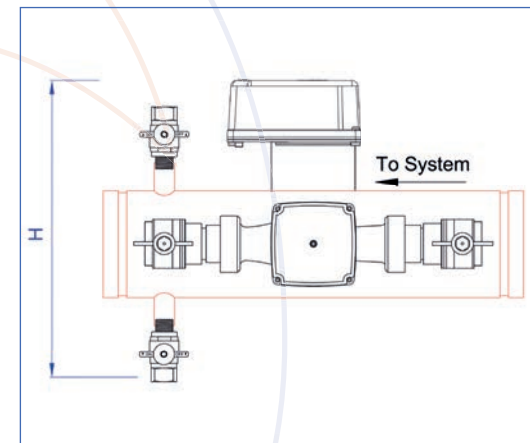

Pipe NB (mm)	Pipe NB (in)	W (mm)	H (mm)	Net Weight (kg)	Packed Weight (kg)
50	2	253	267	8.0	11.5
65	2½	262	279	8.5	12.0
80	3	274	296	10.0	13.5
100	4	300	320	11.5	15.0
150	6	354	371	15.5	19.0



Flow Test Assemblies

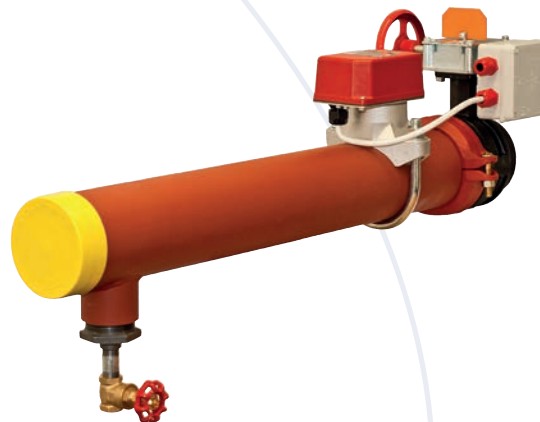

Our Flow Test Assembly is designed for use within zoned sprinkler systems, for example shop units or high rise buildings. The components are fitted to a fabricated and painted grooved pipe, and the flow switch and valve are wired into a single junction box for quick installation on site.

We only use LPCB/FM-approved Potter flow switches to detect the flow of water as a result of a sprinkler head activating; the flow switch sends a signal to an alarm panel or BMS to indicate which zone has been activated.

Each unit comes complete with an LPCB/FM-approved monitored butterfly valve as standard (although different valves can be used on request).

The test/drain outlet is used to drain the water from each zone, or to simulate a sprinkler activation, thus testing the flow switch.

These assemblies require physical attendance for testing purposes since the test/drain valve is manually operated – if this would be difficult or impossible (or wasting water is undesirable) then you may consider our ZONE GUARDIAN (page 7) which allows you to carry out the flow switch testing remotely without loss of water.

Specification

- Grooved steel tube to EN10255 (BS1387) finished in red oxide.
- LPCB/FM-approved grooved butterfly valve with hand wheel and gearbox, open/shut indicators and tamperproof switches indicating open or closed status.
- Potter VSR-EU flow switch with adjustable retard.
- FP200 cable, pre-wired into a junction box from the valve and switch.
- ½" brass valve for test/drain, if required.

Dimensions & Options

Any non-standard length available to order.

- Sizes: 2", 2½", 3", 4", 6", 8".
- Less expensive BS butterfly valves available on request.
- Powder coating in any specified colour.

Please contact us if you require something different – we pride ourselves on our responsiveness, flexibility and quality and are therefore happy to manufacture or source to your own requirements wherever possible.

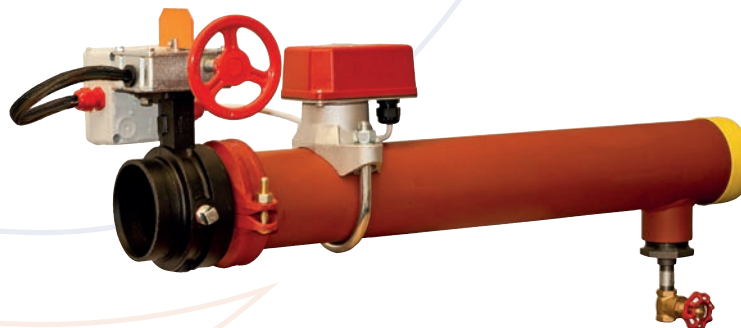

Specialist air compressors have been the backbone of SEP since its inception over 30 years ago. We manufacture a comprehensive range of air compressors suitable for dry, pre-action, alternate or tail-end sprinkler systems.

All of our compressors are designed to comply as far as possible with LPC, EN12845 guidelines, FM Approvals, PED 97/23/EC, and are fully set and tested prior to despatch. Most models are available with or without air receivers/tanks (a requirement for FM systems), or for low-pressure applications.

Whatever your system size, valve type or pressure, we have a suitable model for you, and can help with sizing and specification based on your power supply, pressure and system volume information.

Our compressors are built and tested to exacting standards for quality, reliability and longevity; cheaper compressors are available from others. Please visit our 'Downloads' page for individual model detailed data sheets, O&M documentation and our easy-reference notes on LPC and FM guidelines.

Our Sprinkler Compressor Range

Our Ranges

Compact standard models (page 10) from 1.5-2.2kw with gross outputs from 220 to 336 lpm.

Ultra-quiet oil-free models (page 11) 0.75/1.5kw, 165/232 lpm.

Belt-driven units (page 12) from 2.2-7.5kw with gross outputs ranging from 400 to over 1,000 lpm.

Our **unique Duplex** compressors (page 13).

Air drying & Pressure Maintenance accessories (pages 14-15)

Key Features

- **Standard:** pressure switch set ~2.5-3.5 bar (minimum differential 0.8 bar).
- **Low pressure** upgrade: for cut-out below 2.5 bar or differential between 0.15-0.8 bar ('LP' models).
- Pressure **safety** relief valve.
- Glycerine-filled 63mm **pressure gauge**.
- Contactor starter with thermal overload electrical **protection**.
- Unloader valve and non-return valve prevents compressor starting under load.
- On-delay timer to prevent immediate cut-in in the event of sprinkler activation.
- Flexible hose with ½" adaptor.
- Integrated brackets for wall-mounting (floor mounting kits available).
- Hard-wearing powder coated frame in our trademark silver hammer.
- All air receivers CE-marked ('AR' models).
- Launched in 2021: 0.75kw ultra-quiet oil-free, just 58dB(A)!
- Launched in 2023: 1.5kw oil-free ultra-quiet and 2.2kw mid-range on 50L air receiver.



Model: SEP07S.AR



Model: SEP1.5S



Model: SEP17T



Compact Standard Compressors

Our standard 'LPC' range of wall-mounted compressors have formed a significant part of our business for many years – all of our compressors are designed to meet as many LPC, FM and NFPA guidelines as possible, then built and tested in accordance with our high quality standards.

With the exception of our SEP2.2S, all models are available with or without 24L air receiver, although it should always be noted that if you are using restrictions, regulators or air maintenance devices then a receiver model is vital.

Many of our latest models replace the 'stalwart' models which have been popular for many years – the SEP1.5S replacing the SEP550S, the SEP1.8S replacing the SEP850S, and the SEP1.8T replacing the SEP850T – but the new pumps are the next level up in terms of specification and efficiency.

Newly **launched in 2023**, however, is our SEP2.2S which sits very nicely in the middle of the 'compact standard' and 'belt-driven' range. We still class it as compact because, although it is 2.2kw/3HP with an output of up to 336lpm and sits on a larger 50L air receiver (floor-mounted), it is still direct-drive as opposed to belt-driven.

All models include the specifications noted on page 9.



Model: SEP1.5S



Model: SEP1.8T.AR



Model: SEP2.2S.AR50

The table below demonstrates our range of specialist compressors, in this range, in order of approximate output. Detailed datasheets for each model are available from our Downloads page.

Model Ref	FAD Cfm/lpm @ ~2 bar	Gross Cfm/lpm	Power Volt/Ph*	kW/HP	Noise dB(A)
SEP550S/OF	5.5/160	7.7/220	230/1	1.5/2.0	75
SEP1.5S	6.4/180	7.6/220	230/1	1.5/2.0	76
SEP1.8S	7.2/205	8.7/250	230/1	1.8/2.5	76
SEP1.8T	7.2/205	8.7/250	400/3	1.8/2.5	77
SEP2.2S	9.7/275	11.9/336	230/1	2.2/3.0	77

Technical information

Voltage	230v (1ph) or 4000v (3ph)
Power	1.5kw/2hp to 2.2kw/3hp
Air output	Gross 220-336lpm (FAD 160-275lpm)
Noise level	77 dB(A)

	Non-receiver	Receiver
Dimensions	W57cm D31cm H36cm	W62cm D36cm H67cm
Weight	24kg	47kg

In 2021, we launched our quietest compressor ever – developed for a demanding market sector where dry system pressurisation may be required near to offices, reception areas and other working environments. This pump runs at **just 58dB(A)** (somewhere between a fridge and background office noise) and being oil-free is very low maintenance.

In 2023, we launched our second ultra-quiet oil-free compressor, a 1.5kw model with a highly efficient output of up to 232 lpm.

The smaller compressor comprises a 230v/0.75kw/1HP reciprocating twin-head pump unit driven directly by a standard electric motor. This smaller compressor is available with or without a 24L CE-marked air receiver, underhanging for easy installation.

The larger 230v/1.5kw/2HP unit is also a reciprocating twin-head direct-drive pump unit. Due to its weight and size, this model is only available with our 24L CE-marked air receiver.

Floor-mounting kits are available as an option. Air maintenance devices and filter/regulators are available for use with receiver models.

These compressors are specifically designed and built to help you meet as many LPCB guidelines as possible; the only additional requirement for an FM/NFPA system is an air receiver.



Model: SEP0.7S/OFQ



Model: SEP1.5S/OFQ

Ultra-Quiet Oil-Free Compressors



Technical information

Voltage	230v (1ph)	
Power	0.75kw/1hp (FLC 5A) or 1.5kw/2hp (FLC 10A)	
Air output	Gross 165-232lpm (FAD 108-215lpm)	
Noise level	Just 58 dB(A)	
Dimensions	Non-receiver (0.75kw only)	Receiver
Weight	W57cm D31cm H36cm	W62cm D36cm H67cm
	24kg	47 - 55kg

The table below demonstrates our range of specialist compressors, in this range. Detailed datasheets for each model are available from our Downloads page.

Model Ref	FAD Cfm/lpm @ ~2 bar	Gross Cfm/lpm	Power Volt/Ph*	kW/HP	Noise dB(A)
SEP0.7S/OFQ	3.8/108	5.8/165	230/1	0.75/1.0	* 58 *
SEP1.5S/OFQ	7.6/215	8.2/232	230/1	1.5/2.0	* 58 *



Belt-Driven Compressors

Our compact and ultra-quiet ranges of compressors are most popular, since most dry fire sprinkler systems are relatively small and low pressure. However, for higher capacities and/or higher pressures where greater output is required (e.g. larger systems, multiple valve sets, older 'leaky' systems) then our range of belt-driven compressors is available.

With output (FAD) ranging from 10cfm/285lpm up to 23cfm/645lpm, with or without an air receiver, these will almost certainly be big enough for virtually any fire sprinkler system.

Using the same range of high-quality components as our wall-mounted range, for pipework and electrical trimming, and built and tested to the same exacting standards, these units are hard to beat for any large system.



Model: SEP17T

Technical information

Voltage	230v (1ph) or 400v {3ph}
Power	2.2kw/3hp to 7.5kw/10hp
Air output	Gross 400-1.080lpm (FAD 285-760lpm)
Noise level	77 dB(A)



Model: SEP17T - Vertical

The table below demonstrates our range of specialist compressors, in this range, in order of approximate output. Detailed datasheets for each model are available from our Downloads page.

Model Ref	FAD Cfm/lpm @ ~2 bar	Gross Cfm/lpm	Power Volt/Ph*	kW/HP	Noise dB(A)
SEP10.3S	10.1/285	14/400	230/1	2.2/3.0	77
SEP10.3T	10.1/285	14/400	400/3	2.2/3.0	77
SEP13.8S	13.5/380	18/500	230/1	3.0/4.0	77
SEP17.0T	17.7/500	23/650	400/3	4.0/5.5	77
SEP23.0T	23.0/650	30/820	400/3	5.5/7.5	77
SEP27.0T	27.0/760	38/1,080	400/3	7.5/10	77

Unique to SEP is our duplex compressor station. Two compressor pumps automatically controlled on a coincident and/or alternate basis to give additional output at low pressures, load-sharing, and backup for maintenance purposes.

Duplex compressors are made to our customers' individual specifications for a number of reasons – resilience/backup in case of failure (pump wear is shared during normal use, and a manual override allows continued operation during maintenance); additional capacity in the absence of 3-phase supply (two 230v pumps can give up to 17cfm), or maybe just that they look top-end!

All duplex stations are supplied with 24L air receivers, so an air maintenance device can be used; they may also be used with air dryers for chiller/freezer applications; each is designed, built, tuned and tested to your individual requirements and our exacting quality standards.

Key Standard Functions & features

- **AUTO:** Fast-fill mode – both pumps operate together for maximum output; maintenance mode – pumps alternate to share load.
- **MANUAL:** Either pump can be selected individually.
- Full control panel with isolator, thermal overloads, load-sharing relay to manage compressor utilisation, LED indicators for power, fault & running status.
- Solenoid unloader valves and non-return valves prevents compressors starting under load.
- Pressure switches to control sharing relay (or pumps in 'manual' mode).
- Pressure safety relief valve.
- Floor-standing as standard, but can be made for wall-mounting.
- Anti-vibration mounts for each pump.
- Air receiver 24 litre 11 bar receiver with drain valve.

Options

- Supply faulty relay connection to alarm/panel.
- Automatic (timed) receiver drain.
- Connections for low pressure alarm.
- Run-time counters.

Data Table

Model	Volt/Ph*	kW/hp	Gross Cfm/lpm	FAD Cfm/lpm
SEP0.7S/DC	230/1	1.5/2.0	11.6/330	7.6/216
SEP1.5S/DC	230/1	3.0/4.0	15.4/440	12.8/360
SEP550SOF/DC	230/1	3.0/4.0	15.4/440	11.0/320
SEP1.8S/DC	230/1	3.6/5.0	17.4/500	14.4/410
SEP1.8T/DC	400/3	3.6/5.0	17.4/500	14.4/410

* 400v/3-phase supply **must** have neutral connection

Special Duplex Compressors



Air compressors are used within fire sprinkler systems to maintain dry pipe systems where there is a risk of water freezing in the pipes...roof spaces, canopies, loading bays, warehouses etc.

Where air temperatures are almost permanently very low (for example industrial chillers and freezers), and warmer air is introduced via a compressor, then there is a significant risk of ice plugs forming from frozen condensation.

When warm air enters a chilled environment and rapidly cools, moisture within it condenses and can accumulate within the pipes, eventually icing the entire cross-section of the pipe. These ice plugs will prevent a sprinkler system from operating by impeding or completely blocking the flow of water

to the sprinkler heads. It is not advisable to try to avoid this situation by taking chilled air through the compressor, due to the risk of thickening lubricant and causing physical damage to the components.

Drying ambient-temperature compressed air prior to entry into the chilled pipework strongly mitigates or eliminates this risk of ice plugs, enabling the sprinkler system to function as designed when required.

All of our receiver model compressors can be used with air dryers (we do not advise the use of non-receiver models due to the risk of back-pressure), and we recommend the use of oil removal pre-filters to maximise the efficiency and longevity of the desiccant medium.

The air dryers that we recommend require no separate power supply or electronically-controlled purging, making them cheaper and simpler to run and maintain – the only maintenance cost is a periodic cartridge change.

Desiccant Air dryer

- In-line easy installation.
- Low pressure dew point down to -40°C .
- Cartridge lifetime approx. 1,000 working hours.
- Replaceable desiccant cartridge – quick and simple to maintain.
- Low pressure loss.
- One single model up to 17cfm, suitable for almost all SEP compressors.
- Compact size, less than 300mm high (130mm wide).

Oil removal filter

- In-line easy installation.
- Optional differential pressure gauge indicates when maintenance required.
- Automatic brass drain assembly for condensate.
- Replaceable filter cartridge – quick and simple to change.
- Oil removal down to 0.01mg/m; particle removal down to 0.01 micron.
- One single model up to 25cfm, suitable for all SEP compressors.
- Compact size, 150mm high (90mm wide).



Air Drying Equipment



We manufacture and stock our own multi-functional **Air Maintenance Devices**, used to maintain pressure in sprinkler systems that run off the works main air supply or a separate compressor with receiver.

They can be used to supply fine control to the sprinkler system (whereas a pressure switch is 'up and down'), or used with a standard-pressure compressor where low pressure is required for the system (e.g. Victaulic valves or pre-action systems), or just to provide a 'fast-fill' and a 'maintenance' line for the system.

We strongly recommend that you do not use an air maintenance device (or regulator, or localised restricted orifice) on a compressor without receiver as this will prevent the pump working properly, lead to hunting, and quickly damage the motor.

The Air Maintenance Device maintains the outgoing air accurately at the required pressure. In 'maintenance mode', the air supply is directed through an orifice so that when a sprinkler head is activated, the air supply will not interfere with the operation of the dry valve. In 'fast-fill mode' the full-bore bypass allows maximum throughput.

Key Features

- Pressure regulator to allow setting down to 0.5 bar with locking cap.
- Ball valves for fast-fill bypass, and test.
- Glycerine filled pressure gauge.
- Brass restricted orifice plate.
- Spring non return valve.
- Y-strainer to minimize contamination.

Additional Options

- Lockable ball valves.
- Air filter/regulator with drain.



Pressure Maintenance



If you do not require a full air maintenance device, but still need to fine-tune your air supply, then we offer a range of cost-effective **air regulators and filter-regulators** conforming to ISO6953-1 and ISO5782-1.



The photos illustrate only the most popular models; please contact us if you require something different – we pride ourselves on our responsiveness, flexibility and quality and are therefore happy to manufacture to your own requirements wherever possible.



As a major buyer of compressors and compressor pumps, SEP has access to most European manufacturers' 'off the shelf' ranges at competitive prices, and we can therefore offer you the best solution to your Industrial, Professional and Automotive requirements.

Our selection, sourced for customer service, fast response, quality, reliability and efficiency includes (but is certainly not limited to!) Nuair, Fini, ABAC, Bambi, Kaeser and Fiac – to name but a few.

As well as new and replacement compressors, we can help you source consumables, spares and replacement parts through our network of contacts.

We believe our product range represents the most comprehensive portfolio of compressed air equipment offered, suitable for hundreds of applications.

Just give us a call, or drop us an email, with your requirements and we will quickly provide our recommendation and competitive pricing.



Off-the-shelf Compressors



Jockey Pumps



As a major supplier of specialist products to the fire sprinkler industry, SEP has access to preferential pricing and top quality support to enable us to supply the **best jockey and booster pump** for your needs.

Alongside what is often considered to be the 'industry standard' Grundfos pumps, we regularly supply quality pumps from Lowara, and many other suppliers including Efaflu, Pedrollo, Calpeda etc.

Models and prices depend on the voltage, duty flow rates and pressures required, themselves determined by the sprinkler system and local water supply characteristics (or whether the system is tank-fed).



We can certainly help you with specification, but we will need to know (1) your **power** supply (230v or 400v/3-phase), (2) the **pressure** required as a minimum.

The following ranges tend to be most popular, but of course the exact model depends on your requirements:

- Jockey Pump models are usually vertical multistage Grundfos CR(i), Lowara e-SV.
- Smaller Booster Pump models tend to be horizontal Grundfos CM, Lowara HM.
- Pump starter boxes can be quickly made in-house to suit your specification (230v/400v, thermal overload), and we can supply various pressure switches as required.

Special Applications

- We manufacture compact integrated booster pump sets specifically for the prevention of alarm valve false alarms due to mains pressure volatility – please see our Alarm Valve Booster Pump on page 20.
- We source and supply booster pump sets specifically for domestic and residential fire sprinkler systems – please see our Domestic & Residential on page 24.

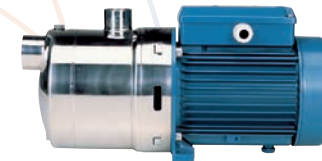

Please remember we **always** need to know your power and pressure when enquiring about pumps!

The range referred to covers only the most popular models; please contact us if you require something different – we pride ourselves on our responsiveness, flexibility and quality and are therefore happy to meet your requirements wherever possible.



Pump Initiation Boards - Wet Riser

Sale Engineering Products originally developed this compact, lightweight modular pump initiation board, designed to meet all the requirements of LPC and BS5306, and latterly BSEN12845.

The highly compact SEP Pump Initiation Board is often copied but never bettered.

Our pump test assemblies are directly mounted onto polypropylene boards for ease and speed of on-site installation. Each jockey and pump arrangement has a separate test assembly, complete with pressure switches, pressure gauges, test valves with control orifice all of which are connected to a common drain.

All materials supplied comply with PED 97/23/EC, and are fully leak tested prior to despatch.

Key Features - BS5306 / Wet Riser models

- Mounted on 9mm polypropylene board for ease of installation and zero corrosion/degradation.
- Inlet and outlet ½"/15nb BSP.
- Bailey & Mackey pressure switches 1381v & 1381.
- Glycerine filled pressure gauges with no loss connectors.
- Non-return valves on pump bypass (not included on jockey to make setting of the 'V' switch easier).
- Test valves with control orifice.
- ½" HQ pipe fittings with top-quality galvanised pipework.
- Descriptive labels provided to your requirements.
- Open (standard) or piped (to order) drain as required.
- *14 bar standard, 25 & 40 bar available.

Galvanised drain

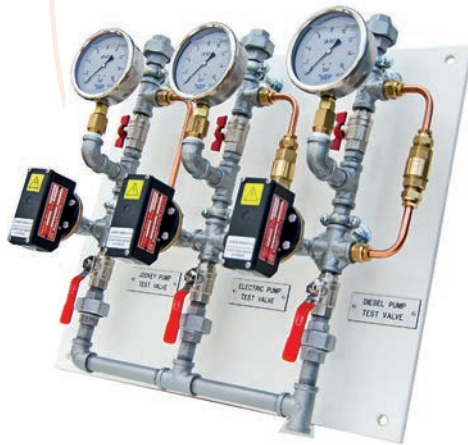

CPVC drain



Description	Model	Standard Pressure*	Dimensions (HxW mm)
BS5306 - Jockey only	PTBS-J	14 bar	600x230
BS5306 - Jockey + 1 pump	PTBS-J1P	14 bar	600x400
BS5306 - Jockey + 2 pumps	PTBS-J2P	14 bar	600x560
BS5306 - Jockey + 3 pumps	PTBS-J3P	14 bar	600x890

For our sprinkler initiation panels, our unique 4-port valve (EN12845 boards only) minimises the number of joints and makes testing and maintenance a painless task.

Additional Features – EN12845 / Fire Sprinkler models

- Double switch arrangement for pumps as required by EN12845.
- 4-port valve allows easy testing of individual switches and gauges.
- Open drain assembly for easily visible water flow.
- The most compact assembly on the market.

CPVC drain

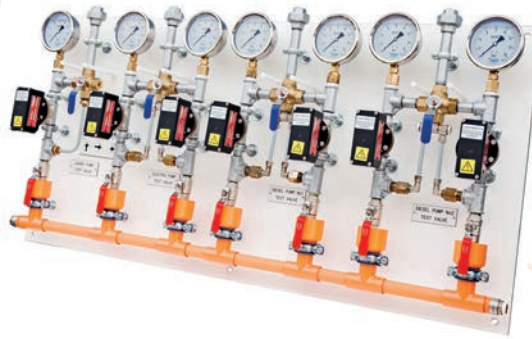

Galvanised drain



Pump Initiation Boards - Fire Sprinkler



Why our EN Pump Initiation Board is the best:

- Our **unique 4-port valve** allows total isolation for maintenance - change gauges, switches and NRVs with ease when compared to other board assemblies.
- Smaller weights and dimensions than competitor boards.
- Fewer joints than many boards, minimising the risk of leakage.
- Polypropylene board subject to zero corrosion.
- Orifice valves allow more accurate test measurement.

Options/Upgrades

- **Standard boards** include 14 bar switches and 16 bar gauges.
- For **higher pressures**, pipework and switches/gauges suitable for either 25 bar or 40 bar.
- For lower pressures, we can provide 11 bar switches and 7 or 11 bar gauges.
- We can also manufacture with special switches such as Allen Bradley, Danfoss or even pressure transducers.

Description	Model	Standard Pressure*	Dimensions (HxW mm)
EN12845 – Jockey only	PTEN-J	14 bar	600x230
EN12845 – Jockey + 1 pump	PTEN-J1P	14 bar	600x560
EN12845 – Jockey + 2 pumps	PTEN-J2P	14 bar	600x890
EN12845 – Jockey + 3 pumps	PTEN-J3P	14 bar	600x1220

Only the most popular configurations are shown above; please contact us as we will manufacture any configuration and pressure rating required – we pride ourselves on our responsiveness, flexibility and quality.



False/Alarm Valve Booster Pumps

We manufacture a range of Alarm Valve Booster Pumps (also known as False Alarm Booster Pumps or Town Main Booster Pumps) for sprinkler systems that are **fed from the water main**.

This compact unit (only 600 x 400mm) automatically boosts the town's mains pressure when required, removing pressure fluctuations in conjunction with the accumulator, thus **preventing false trips** of the alarm valve.

Mains +4 bar



The alarm valve booster pump is fitted as standard with an 8-litre accumulator, designed to prolong the life of the pump by eliminating unnecessary motor stops/starts, and allowing the pump an extended run when the cut-in pressure is achieved.

All units are designed to comply with LPC guidelines, and are fully set and tested prior to dispatch.

Key Features

- Low-flow pressurising pump, will not affect sprinkler activation.
- Pressurised accumulator (10/25 bar).
- On-delay timer (400v models must have neutral for a 230v supply) to limit the number of pump starts, prolonging its life and preventing overheating.
- Bailey & Mackey 1381v pressure switch.
- Contactor starter with thermal overload.
- Y-strainer for inlet; outlet and test valves also included.
- Spring check valve to prevent backflow.
- Glycerine filled pressure gauge with no loss connector.
- Polypropylene board and Unistrut mounted for direct wall mounting.
- All connections are ½"BSPT/15mmNB.

It is important to select the correct model when purchasing - the '4 bar' unit will be suitable for the significant majority of applications, but if pressure or volatility is high then the '9 bar' model may be required.

Which model do I need?

What is your MAXIMUM mains water pressure?	What is your mains water pressure TESTED VARIATION (i.e. maximum less minimum)?	Which model do you need?
<9.5 bar*	<3.6 bar*	AVBP/S.AC/4BAR*
	>3.6 bar	AVBP/S.AC/9BAR
>9.5 bar	<8 bar	AVBP/S.AC/9BAR

*most likely scenario

Description	Model	Volt/Ph	kW/hp	Max press
Single phase, mains +4 bar pressure	AVBP/S.AC/4BAR	230/1	0.4/0.5	10 bar
Single phase, mains +9 bar pressure	AVBP/S.AC/9BAR	230/1	0.5/0.7	25 bar
Three phase*, mains +4 bar pressure	AVBP/T.AC/4BAR	400/3	0.4/0.5	10 bar
Three phase*, mains +9 bar pressure	AVBP/T.AC/9BAR	400/3	0.5/0.7	25 bar

*3-phase models require a neutral supply for the on-delay timer 230v connection.

Mains +9 bar



The standard models are shown above; please contact us if you require something different – we pride ourselves on our responsiveness, flexibility and quality and are therefore happy to manufacture to your own requirements wherever possible.



Dry Riser Test Pump

As part of our growing range of pump and test equipment, SEP offers this unique Dry Riser Test Pump set-up.

Using an electric vertical multistage pump with a comprehensive outlet manifold, pressure switch controls, and mounted on a steel skid, our unit solves many problems encountered during the challenge of dry riser pressure testing.

Many operators are sceptical about leaving their 'trustworthy Godiva' pump; however, those that do say that they will never go back to 'the old way' of carrying out dry riser testing!

As always, when buying from us, you will expect high levels of service and top quality, as well as some or all of the following numerous advantages compared to standard dry riser testing methods:

- Virtually no noise compared to running and revving petrol-driven pumps, making it perfect for buildings such as residential, office, school, care home etc.
- 230v pump can be easily powered from maintenance vehicles using an in-vehicle inverter, generator or even local accessible power supply (see over for more details).
- Pressure switch ensures the pump runs only to your pre-determined set pressure, cutting in again only if required.
- No need to carry, manoeuvre, start (or try to!) and continually rev up heavy petrol- or diesel-driven pumps.
- No need to carry a separate and risky flammable fuel supply.
- Pump set can be fed by vehicle-mounted water tank or external hydrant supply.
- No need to remove pump set from vehicle to carry out testing routines.
- Test sequence can become a one-person task instead of multi-person.
- Increased reliability and easy maintenance using off-the-shelf parts familiar to most fire sprinkler engineers.
- 1" and 2" outlets allowing feed into instantaneous fitting hoses.
- Additional and/or different valves/outlets can be fabricated to suit customers' preferences.



Standard specification includes:

- 230v vertical multistage pump (standard is Grundfos CRi1-23 with Hmax 135m and Qmax 38lpm);
- Outlet manifold including 1" and 2" outlets, check valve, pressure switch (Bailey & Mackey 1381, 14 bar) and gauge;
- Electrical control module, loose for mounting where convenient;
- Mounted on a steel-skid with bolt-holes for full stability and clean looks.

As standard, we're NOT standard, so we offer the following options:

- Calibration certificate for pressure gauge.
- Instantaneous male or female fittings.
- Lay-flat hoses complete with instantaneous connections.
- Need higher pressure or higher flow? We can upgrade to any 230v pump (up to 2.2kW) but please ensure your power supply is suitable.
- Manifold design and build to suit your individual requirements, including different outlets and connections.
- IBC water tank with adaptors/fittings.
- Petrol generator. Although this solution negates one of the advantages, many engineers carry this kit anyway. Cost is around £300-500.
- Power inverter. A pure sine wave DC12V to AC230V inverter connected directly to the vehicle battery. We know several customers are using this solution without any problems, although according to the inverter specialists this may cause early wear to the vehicle battery. All we would suggest is that you have the vehicle battery checked regularly. Cost is around £400-500.
- Full inverter kit. This is the 'gold-standard' solution (but we are not aware of any customer that has needed to use this) including an inverter with 230v charger, a pair of heavy-duty leisure batteries and a DC-DC charger. The cost is, in our opinion, quite high at around £2,000.

Weights and Dimensions

Height approx.	950mm
Footprint approx.	600x500mm
Weight approx.	50kg

Power Supply Options

We are regularly asked by customers and potential customers about the best option/s for supplying power for the dry riser test pump. The answer is not simple, and we are not specialists in this area; however, we are able to offer advice based on research and discussions with both power supply specialists, and customers who have been using the unit for some time.

Based on the above, we suggest the following possible solutions for consideration.

- 230v extension leads: yes, some users have this as a solution – certainly cheap, also quick and easy where possible, but this may not always be the case and leaves you reliant on access to power points.

For detailed specification, the electrical specifications of the standard Grundfos CRi1-23 pump used are:

- Voltage 220-240v
- Power rating 1.1kW
- Frequency 50Hz
- Rated current 7.40/6.70A
- Starting current 390% (bear this in mind when sizing power supply)

We repeat that we are not electrical specialists and are not able to supply the above as standard; there is not one solution which will be suitable for everybody so please take advice.

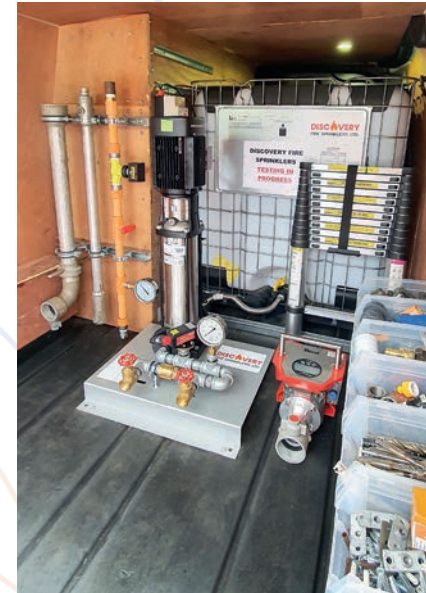

The residential/domestic fire sprinkler market is **growing** in importance and size, therefore SEP offers a choice of booster pump sets for this application to suit different applications and budgets – we are a **nominated distributor for Grundfos FireSAFE+**, but can also offer DutyPoint ResiSHIELD and Lowara Hydroquench sets.

Uniquely, we also hold a stock of Grundfos CM pump kits at our warehouse.

Models and prices depend on the flow rates and pressures required (please have this information ready when enquiring), depending on the sprinkler system and local water pressure or whether the system is to be tank-fed.

The range outlined covers selected models, all of which are BS9251:2021 compliant; please contact us with your requirements – we pride ourselves on our responsiveness, flexibility and quality and are therefore happy to recommend and source to suit your specific requirements.

The Domestic Range provides a compact, installer-friendly unit based on the Grundfos 'CM' pump to suit the growing demand for domestic fire suppression systems and recent legislative changes.

- Very compact - footprint as small as 421x233mm, height as low as 413mm.
- Flow range up to 240lpm, pressure range 1.0-4.6 bar.

The Residential Range is based on the Grundfos 'CR/CRI' vertical pump, designed to operate both sprinkler and water-misting systems requiring greater outputs at higher pressures.

- Also incorporates a water flow alarm switch.
- Footprint from 810x370mm, height from 575mm.
- Flow range up to 800lpm, pressure up to 14 bar.



Residential & Domestic Pumps

Grundfos FireSAFE+

Grundfos has used its vast experience of producing dependable pumps, and extensive expertise in commercial fire suppression systems to produce two related ranges for this market. The FireSAFE+ range was fully launched in 2023 to **meet all requirements of BS9251:2021**.

Both ranges include the following as standard:

- User-friendly control panel (Full LCD screen on Residential units) with anti-tamper protection, weekly self-test, full data-logging including simple upload/download.
- Automatic top-up via continuous pressure monitoring; intelligent pump cooling line solenoid valve control.
- Dual discharge pressure switches, ensuring redundancy.
- Volt-free contacts for remote monitoring of status.
- Test line connection and system drain point.



Lowara Hydroquench

We have offered Hydroquench 3000 range for many years, offering the following features:

- Automatic self-test cycle (variable frequency set 4-28 days), and manual test.
- Volt-free contacts for unit status and operational alarm.
- Vessel to accommodate expansion and maintain pressure against small leaks.
- Footprint from 700x340mm, height from 640mm.
- Flow range up to 400lpm, pressure up to 6 bar.
- At the time of publication, the Lowara set are compliant only with the 2014 standard, not 2021.



Residential & Domestic Accessories

- Priority Demand Valves (page 26).
- Resi Risers (page 28).
- Monitored Ball Valves (page 29).
- Zone Guardian Resi (page 30).

Example Model	Power	Max pressure	Max flow	Approx mid-point	Dimensions (LxWxH cm)
Grundfos Domestic (3 models listed of 7 available)					
CM3-3	230v/1ph	2.7 bar	80lpm	40lpm @ 2.2 bar	44x23x41
CM5-3	230v/1ph	2.8 bar	100lpm	50lpm @ 2.4 bar	44x23x41
CM10-3	230v/1ph	4.8 bar	235lpm	120lpm @ 4.2 bar	56x31x44
Grundfos Residential (4 models listed of over 25 available)					
CR(i)5-5	230v/1ph	3.3 bar	210lpm	60lpm @ 2.8 bar	61x37x85
CR(i)10-6	230v/1ph	5.5 bar	210lpm	100lpm @ 5.2 bar	61x37x85
CR(i)15-9	400v/3ph	12.5 bar	400lpm	200lpm @ 11.5 bar	61x37x120
CR(i)20-17	400v/3ph	25 bar	400lpm	200lpm @ 23.5 bar	61x37x85
Lowara					
3HM06P	230v/1ph	4.4 bar	75lpm	50lpm @ 3.0 bar	70x34x64
5HM05S	230v/1ph	3.8 bar	140lpm	80lpm @ 3.2 bar	70x34x64
22SV06	400v/3ph	9.3 bar	480lpm	400lpm @ 6.0 bar	100x40x109

Only a small selection is shown above; please contact us as we will advise on the full range of flow and pressure options available – we pride ourselves on our responsiveness, flexibility and quality.



Priority Demand Valves

The SEP Priority Demand Valve (PDV) – launched in 2021 – acts to **isolate the domestic/ ancillary water supply in the event of a fire sprinkler activation**, or in the event of a power loss (fail-safe).

The Requirement

BS9251 – the standard for ‘fire sprinkler systems for domestic and residential occupancies’ – states in broad terms that IF:

- the mains water supply flow rate available to the fire sprinkler system is liable to be affected by domestic water usage (e.g. shower, washing machine etc), THEN
- a valve must be fitted to cut off supply for domestic use in the event of a sprinkler activation.

Two Products – One Solution

- For pipe sizes from 15mm/½" up to 50mm/2" we use a quality solenoid valve with BSP threaded connections.
- For pipe sizes from 65mm/2½" up to 50mm/6" we use an electrically actuated butterfly valve for flanged connections.

The Benefits of our product

- All valves are WRAS-approved and therefore can be fitted directly to the mains water supply.
- 24-volt solenoid valve coil and control circuits avoid the need for dangerous 240-volt power outside the IP-rated enclosure, in a domestic environment.
- LED indicator to confirm that power is present.
- LED and position indicators on butterfly valve actuator.
- Fail-safe – the valve closes if a signal is received from the sprinkler system flow switch, BUT it will also close in the event of power loss OR flow switch connection is lost, ensuring that the fire sprinkler is always safe.
- High IP rating means more flexibility when positioning the easy-mount enclosure and the valve itself.
- Small enclosure for Solenoid-type (just 170x80x85mm).
- The fail-safe functionality does not preclude the installation of a (restricted/15mm/½") bypass around the PDV (complete with lockable and/or monitored isolation valve) to allow the provision of emergency water supplies in the event of a power loss which is not caused by a fire event.

Workings and features

- The flow switch (water flow detector) is connected into the IP-rated enclosure, creating a circuit that maintains the valve in the open position. If the flow switch is activated then the circuit is broken which closes the valve and shuts off the domestic water supply.
- It is strongly recommended that an **approved flow switch** is used with this installation, which gives added benefits of false alarm protection and two sets of contacts, as well as the peace of mind which comes with using proven globally-approved products.
- The unit is provided with a fitted plug for ease; however, this is easily removed, should the preference be to cable directly into a fused spur.



WRAS APPROVED VALVE

Technical information

	Solenoid Valve	Butterfly Valve
Sizes available	½"/15mm to 2"/50mm	2.5"/65mm to 6"
Pressure range	0.3-16 bar	0-16 bar
Electrical information – enclosure	230VAC / 24W / <1A	230VAC / 24W / <1A
Electrical information – valve	24VDC / 15W / <1A	230VAC / 36-48W / 0.15-0.2A
Size of enclosure	170x80x85mm	190x120x90mm
IP rating of assembly	Minimum IP65	
Mains cable	3-core x 1mm, length 2m, UK plug fitted	
Valve cable	3-core x 0.5mm, length 2m	3-core x 1mm, length 2m
Solenoid valve sizes (L x W x H) in mm	15mm: 80x52x114 (0.9)	65mm: 46x408 (5.0)
Butterfly valve sizes (L x H) in mm (L indicates flange-flange thickness)	20mm: 90x58x121 (1.1) 25mm: 109x70x135 (1.5) 32mm: 120x82x147 (2.2) 40mm: 130x95x161 (3.2) 50mm: 162x113x172 (5.0)	80mm: 46x422 (5.7) 100mm: 52x485 (6.9) 125mm: 56x513 (10.0) 150mm: 56x605 (13.1)
Number in brackets is weight in kg		

Note: Due to availability of specific components, or ongoing design improvements, the technical or design specification may change at any time – if anything is critical then please contact us to confirm prior to ordering.



WRAS APPROVED VALVE

Options

Valves are available non-fail-safe only by special order, if there is concern about loss of domestic water supply in the event of a power loss, however, these valves will not be able to shut off the domestic supply if there is a fire sprinkler activation during such power loss and therefore may not meet the standard.

Related Products

For domestic/residential fire sprinkler systems, **we also supply:**

- Lockable and monitored ball valves in all sizes from 1"/25mm to 2"/50mm
- Residential valve sets ('resi risers') complete with approved Potter flow switch (with two sets of contacts – one for the alarm panel, one of which can be used for the valve)
- Approved Potter flow switches
- As a nominated distributor, BS9251:2021 compliant booster pump sets manufactured in the UK by global pump specialist Grundfos.

Our compact residential riser assembly is designed to be **completely flexible** in its configuration and use, and is intended for low volume special applications. Therefore, rather than a standard 'take it or leave it' design, we can quickly assemble special units to your required configuration for no additional cost.

In addition, we use only LPCB or FM approved Potter VSR-S flow switches - something which many manufacturers do not. If you would prefer to source your own flow switches then the units can be supplied without.



Residential Risers/Valve sets

Key Features

- All stainless steel pipework (vertical or horizontal inlet)
- Potter VSR-S (EU) approved flow switch
- 63mm glycerine filled pressure gauge
- Lockable brass ball valve for test and drain
- The following additional accessories are available with your order for resi riser assemblies:
 - WRAS approved lockable ball valves
 - WRAS approved double check valves with integral test point
 - BSP screwed-to-CPVC adaptors

Residential Riser Assembly Specifications

STYLE

BD

BR

LL

LD



Part No.

SEP-RR25

SEP-RR32

SEP-RR40

SEP-RR50

Size

1"

1 ¼"

1 ½"

2"

'BD' Height x Width cm (approximate)

32 x 29

28 x 25

29 x 31

32 x 29

We are more than happy to discuss special product requirements if you do not see what you are looking for here.



Monitored Ball Valves

Due to our **ever-increasing Residential and Domestic flow of enquiries**, and the recent demands of BS 9251:2021, SEP is pleased to present our monitored ball valve in sizes from 1"/25mm up to 2"/50mm.

BS 9251:2021, section 5.15 states that "except for category 1 systems, all valves which control the flow of water to the system should be electrically monitored for the open position" – SEP can help ensure that all R&D (Residential and Domestic) fire sprinkler system installers meet this requirement, along with many others.

The valve and monitor switch can be purchased stand-alone, or as part of our resi-riser assembly, and the small assembly is simple and lightweight.

As required, the spring switch ensures that the valve is monitored to be 'in the fully open position' – even if slightly closed, a signal will be transmitted to the monitoring panel

Comprising the following:

- PN40 brass ball valve with BSP female threads
- WRAS-approved
- Fully lockable handle (keyed-alike padlocks also available)
- Micro-switch monitoring that the valve is fully open and not tampered with or damaged
- Flexible NC and NO connection options
- Flow switch connections also provided
- ABS enclosure with low flammability rating (UL94-HB)
- IP54-rated enclosure with min IP54-rated cable glands.

If you are installing R&D fire sprinkler systems, did you know we also supply:

- **Booster Pump Sets** – we are a nominated distributor for Grundfos FireSAFE, and the only stockist (even Grundfos themselves do not stock complete units). See page 24.
- **Priority Demand Valves**, designed to isolate the domestic water supply in the event of fire sprinkler system operation, fail-safe design in accordance with BS 9251:2021. See page 26.
- **Resi Risers** (valve sets complete with LPCB-approved flow switch, pressure gauge, lockable test valve), allowing you to meet further BS 9251:2021 requirements. See page 28.
- **Zone Guardian**, zone water flow alarm switch test devices for larger zoned systems. See pages 6 & 30.
- **Wet riser pump initiation and test panels**, where wet risers are installed as part of a larger system. See page 18.
- **Pressure gauges**, switches, flow switches and various other ancillaries. See page 31-34.

Wiring details:

- **VALVE SW** (valve monitoring switch) connections C/NO/NC. NO/NC with spring switch in natural resting position; can be considered reversed when the valve is open and the spring switch is 'cocked'. Circuit must be tested to ensure operation as per design during commissioning.
- **FLOW SW** (flow switch) connections 1/2/3 are provided only as a means of local connection – optional use as required.



Please contact us with your requirements – we pride ourselves on our responsiveness, flexibility and quality and are therefore happy to source whatever you require wherever possible – quickly and at the best price.



Zone Guardian Residential



For sprinkler systems under 2"/50mm, ZONE GUARDIAN is available in 1"/25mm, 1¼"/32mm and 1½"/40mm, in either steel or CPVC.

The residential ZONE GUARDIAN allows the testing of a fire sprinkler system's waterflow detector (flow switch) to be carried out remotely, saving water, time and cost for end-users and maintenance contractors.

The unit ensures zero water wastage, using an artificial water flow created using a high-efficiency self-venting circulator pump manufactured by Grundfos, a global supplier.

The assembly includes – as well as the circulator pump – a Potter VSR-S vane-type flow switch with adjustable retard, and ball valves for pump isolation.

The unit may be installed either horizontally or vertically.

An electronic key-operated test module is included to allow testing of both the local and any interconnected waterflow detectors.



Specification:

Pressure rating: 12 bar (175psi)

Pipe sizes: 1"/25mm, 1¼"/32mm, 1½"/40mm

Flow switch (Potter VSR-S or VSR-SG):

Trigger flow rate: 38lpm with up to 30s retard

Enclosure rating: IP54

Contact rating: 10A @ 125/250VAC; 10mA @ 24VDC

Circulator Pump:

Voltage: 230VAC 50Hz

Power: 60W max

Current: 0.58A max

Test module:

Surface-mounted, key-operated multi-function
Voltage in: 230VAC 50Hz

Voltage out: 230VAC 50Hz (local)
or 24VDC (interconnect)

LEDs: Green: power/standby; Amber: test in progress; Red: flow switch active

IP rating: 56

Dimensions & Weights

Material	Pipe NB (mm)	Pipe NB (in)	L (Pipe Ends) (mm)	W (Pipe-Pump) (mm)	H (Pipe-Switch) (mm)	Net Weight (kg)
Steel	25	1	393	185	170	6.0
Steel	32	1¼	398	195	177	6.4
Steel	40	1½	402	200	185	6.7
CPVC	25	1	418	247	185	5.0
CPVC	32	1¼	418	261	190	5.2
CPVC	40	1½	428	266	204	5.5



We hold a good stock of pressure gauges which are commonly used throughout fire sprinkler systems and manufactured to EN837-1 standards (K1 1 or 1.6).

All our gauges have brass (or stainless) wetted parts, stainless steel casing, pressure safety device and are glycerine-filled as standard.

Calibration/certification of gauges is an almost daily requirement; we can certify any gauge to order using our high-accuracy (0.04%) digital master gauge, normally shipping the same day subject to cut-off time and quantity.

100mm (4") gauges with 3/8" BSP bottom connection. 4, 7, 11, 16, 25 and 40 bar always in stock

100mm compound/suction/vacuum gauges stocked: -1 to +1 bar and -1 to +3 bar

63mm (2½") gauges with ¼" BSP bottom connection. 2, 4, 7, 11 and 20 bar always in stock

1/2" to 3/8" **No Loss Connectors** are also available from stock – our own robust high pressure design, with stainless parts in a brass body. Beware cheap imitations.

Gauge **adaptors** are also stocked to allow 3/8" gauges or ½" no-loss to be used in ¼" ports.

Pressure Gauges

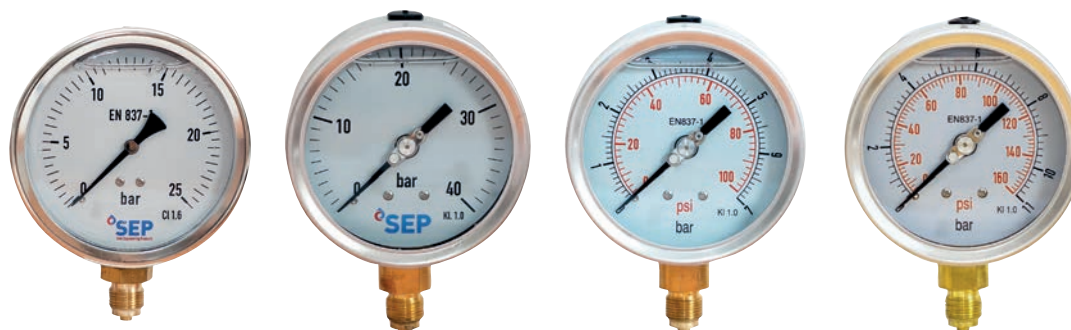

Other Options

- Many more sizes/ranges are available upon request.
- Gauges can be ordered with **your own logo**, subject to minimum order and lead times.
- For larger commitments, we can even create a call-off stock to suit your needs.

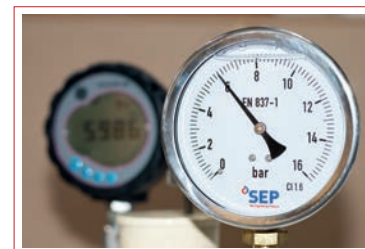



Valves

Sale Engineering Products stock, or can source and supply, a wide range of valves for both manual control and safety (pressure relief/reducing).

The following are standard stock items:

- Safety Relief Valves for air, 2.5, 3.0, 3.5, 4.0 and 5.5 bar (can be factory checked and certified to order)
- Non-return/check valves, spring or swing, ½"/15mm to 2"/50mm
- Compressor non-return/check valves with unloading port, 90° elbow, 3/8"/10mm
- Ball valves, lockable lever, WRAS-approved, ½"/15mm to 4"/100mm or T-handle, ½"/15mm
- Butterfly valves, gear operated, monitored - LPCB/FM-approved.



Diff Valve Kit



The following can be ordered, almost always for a quick delivery:

- Pressure/Safety Relief valves – for air or water, in any other size or pressure rating
- Pressure Reducing valves
- Test & Drain valves
- Virtually any other type or size of control valve

Please contact us with your requirements – we pride ourselves on our responsiveness, flexibility and quality and are therefore happy to source whatever you require wherever possible – quickly and at the best price.

We stock a wide range of essential fire sprinkler system accessories and spare parts. If we don't stock it, we can almost certainly find it, and get it to you quickly.

The following are normally held in stock for next day delivery:

- Potter flow switches, VSR vane-type alarm switch with adjustable retard; multiple approvals; sizes 2"/50mm to 8"/200mm (VSR-EU, with up to 30 second retard); VSR-S (1" screwed) to suit threaded tees from 1"/25mm to 2"/50mm; VSR-SFG for CPVC pipe.
- Stainless Steel and Galvanised orifice unions, machined in-house with brass/bronze orifice plate (3mm orifice standard, or any other size to your requirement); sizes ½"/15mm to 2"/50mm.
- LPC-approved Flow meters – 80/100mm grooved usually in stock; other sizes and types usually available within a few days. Popular spare parts also stocked.



Accessories & Spares

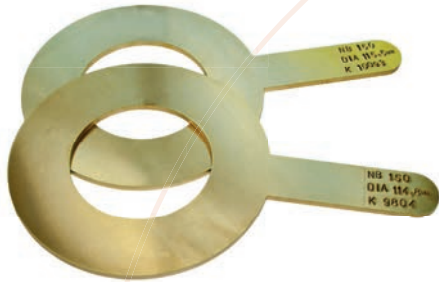

The following can be ordered for fast delivery:

- Orifice plates, brass or special materials, 3mm (normally for NB50-100), 6mm (normally for NB100-150) or 10mm (normally for NB150-200) stamped or etched to include your required data.
- Pipework-to-go, any configuration to your requirement; for instance a recently designed pressure gauge/switch testing/setting device for both air and water.



Please contact us with your requirements – we pride ourselves on our responsiveness, flexibility and quality and are therefore happy to source whatever you require wherever possible – quickly and at the best price.



Pressure Switches



Bailey & Mackey

B&M pressure switches are LPCB approved and therefore widely used within the fire sprinkler industry (they are used as standard on our Alarm Valve Booster Pumps and Pump Initiation Boards), and are readily available from stock in both standard and 'V' options.

- 1381 0.5-11 bar
- 1381 0.7-14 bar (standard pressure)
- 1381 2-28 bar (high pressure)
- 1381 2-42 bar (high pressure)
- 1391 standard 0.7-14 bar



Danfoss

Danfoss CS, RT or KP pressure switches are used as standard on our compressors and are readily available from stock.

- 0.2-6 bar (low pressure & low differential)
- 2-6 bar (standard pressure)
- 4-12 bar (high pressure)
- -0.2-8 bar (often used on water booster sets)

We hold a stock of pressure switches which are commonly used throughout fire sprinkler systems, such as Bailey & Mackey 1381/1381V, Danfoss and Allen Bradley; many other manufacturers' switches are available to order.

Others

We also regularly supply the following:

- Allen Bradley (836T normally in stock)
- Potter/System Sensor (FM/UL approvals)
- Condor
- Nema
- Square D/Schneider Electric



Please contact us if you require something different - we pride ourselves on our responsiveness, flexibility and quality and are therefore happy to source to your own requirements wherever possible.



Where Are We Installed?

Sale Engineering Products could be one of the most important names hidden from public view. Some of the biggest brands - both UK and global - entrust the care of their people and assets to us as part of their fixed fire protection systems. Just a few of them are...



DIAGEO



Heathrow



PRIMARK



ASDA





Sale Engineering Products Ltd,
45 Lambeth Road, Reddish, Stockport, Greater Manchester, SK5 6TW
w: www.firesprinkler.co.uk
t: +44 161 428 1180 e: info@saleengineering.co.uk



Design: www.creationadm.com
Print: www.paragonprinting.co.uk